

CHAMBERLAIN®

**LiftMaster®**  
**PROFESSIONAL**

The Chamberlain Group, Inc.  
845 Larch Avenue  
Elmhurst, Illinois 60126-1196  
www.liftmaster.com



*Radio  
Receiver  
Included*



# **Model MSLXDCBB3**

(MEGA SLIDE X)

**1/2 HP COMMERCIAL DUTY SLIDE GATE OPERATOR**

## **OWNER'S MANUAL**

**THIS UNIT IS A CLASS 1, 2, 3, OR 4 SLIDE GATE OPERATOR FOR USE IN SLIDE GATE APPLICATIONS**

# TABLE OF CONTENTS

**INTRODUCTION**

- Carton Inventory . . . . . 3
- Manual Release . . . . . 3
- UL325 Model Classifications . . . . . 4
- Safety Installation Information . . . . . 5
- Recommended Site Layout Example . . . . . 6
- Safety Precautions for Roller Gates . . . . . 7
- Warning Sign Placement . . . . . 7
- Operator Overview . . . . . 8

**INSTALLATION**

- Concrete Pad . . . . . 9
- Anchors . . . . . 9
- Conduits . . . . . 9
- Chain Installation . . . . . 9
- Safety Edge Installation . . . . . 9

**WIRING AND HOOKUP**

- AC Power Hookup (120/230 Vac) . . . . . 10
- Input Commands 1-8 (3-Button Control Station) . . . . . 11
- Accessory Connections . . . . . 12
- Battery Installation . . . . . 12
- Master/Second Wiring . . . . . 12

**TIMERS AND MODE SELECTIONS S1 & S2**

- Fast Run Timer - S1 . . . . . 13
- Mode Selections - S1 . . . . . 13
- Close Timer - S2 . . . . . 13
- Mode Selections - S2 . . . . . 13

**ADJUSTMENTS**

- Right or Left Hand Operation . . . . . 14
- Limit Switch Adjustments . . . . . 14
- Instant Reverse Device (IRD) . . . . . 14

**RECEIVER**

- Set Security Mode . . . . . 15
- Programming the Remote to the Receiver . . . . . 15
- To Erase All Remote Control Codes . . . . . 15

**OPERATION AND MAINTENANCE**

- General Service . . . . . 16
- Battery Disposal . . . . . 16
- Battery Replacement . . . . . 16
- Battery Maintenance/Testing . . . . . 16
- Battery Handling/Storage . . . . . 16

**TROUBLESHOOTING**

- Battery Checkout . . . . . 17
- Gate Not Operating . . . . . 17

**SUGGESTED LOOP SENSOR LOCATIONS**

- Free Exit on Vehicle Approach . . . . . 18
- Entry With Access Control Device . . . . . 18
- Dual Direction as Entry and Free Exit . . . . . 18

**CONTROL BOARD LAYOUT**

- Component Locations . . . . . 19

- REPAIR PARTS** . . . . . 20
- ACCESSORIES** . . . . . 21
- SAFETY ACCESSORIES FOR SECONDARY ENTRAPMENT PROTECTION** . . . . . 22
- REPAIR PARTS AND SERVICE** . . . . . 22
- WARRANTY** . . . . . 23
- INSTALLATION CHECK OFF LIST** . . . . . 24

**IMPORTANT NOTES**

- BEFORE attempting to install, operate or maintain the operator, you MUST read and fully understand this manual and follow all safety instructions.
- DO NOT attempt repair or service of your commercial door and gate operator unless you are an Authorized Service Technician.

 **WARNING**

Mechanical

 **WARNING**

Electrical

**CAUTION**

When you see these Safety Symbols and Signal Words on the following pages, they will alert you to the possibility of **SERIOUS INJURY** or **DEATH** if you do not comply with the warnings that accompany them. The hazard may come from something mechanical or from electric shock. Read the warnings carefully.

When you see this Signal Word on the following pages, it will alert you to the possibility of damage to your gate and/or the gate operator if you do not comply with the cautionary statements that accompany it. Read them carefully.

# INTRODUCTION

## **CARTON INVENTORY**

Before beginning your installation check that all components were provided and received undamaged. Refer to list below for factory provided parts.

<b>Description</b>	<b>Qty.</b>
Operator	1
Accessory Shelf	1
Owner's Manual	1
Gate Pull Tabs with Hardware (MS205 Pull Tabs, MS204 Chain Bolt)	2
20' (6.1 m) of #41 Nickel Plated Drive Chain (10' (3.05 m) coils, 2 required MS202)	1
Warning Signs	2
Sealed 12 Vdc, 7AH Batteries	2

## **MANUAL RELEASE**

The MANUAL RELEASE switch is located on the left side of the gate operator frame towards the chain. To operate the gate manually, place the MANUAL RELEASE switch in the down position. This will remove power to the motor allowing the gate to be manually opened.

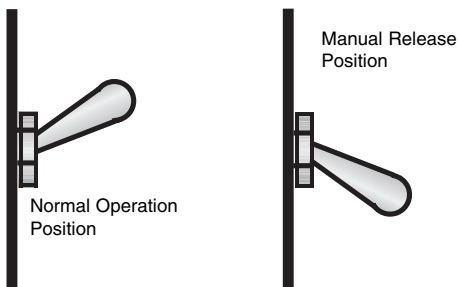

## UL325 MODEL CLASSIFICATIONS

The MSLXDCR is intended for use with vehicular slide gates. The operator can be used with Class I, Class II, Class III and Class IV applications.

### CLASS I – RESIDENTIAL VEHICULAR GATE OPERATOR

A vehicular gate operator (or system) intended for use in a home of one-to four single family dwellings, or a garage or parking area associated therewith.



### CLASS II – COMMERCIAL/GENERAL ACCESS VEHICULAR GATE OPERATOR

A vehicular gate operator (or system) intended for use in a commercial location or building such as a multi-family housing unit (five or more single family units) hotel, garage, retail store or other building servicing the general public.

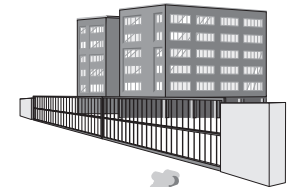

### CLASS III – INDUSTRIAL/LIMITED ACCESS VEHICULAR GATE OPERATOR

A vehicular gate operator (or system) intended for use in an industrial location or building such as a factory or loading dock area or other location not intended to service the general public.

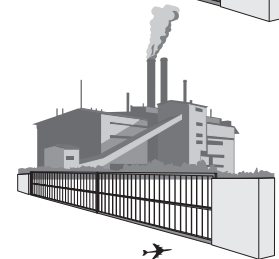

### CLASS IV – RESTRICTED ACCESS VEHICULAR GATE OPERATOR

A vehicular gate operator (or system) intended for use in a guarded industrial location or building such as an airport security area or other restricted access locations not servicing the general public, in which unauthorized access is prevented via supervision by security personnel.

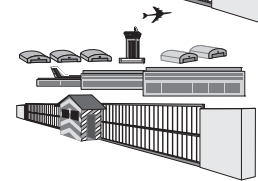

## SAFETY ACCESSORY SELECTION

All UL325 compliant LiftMaster gate operators will accept external entrapment protection devices to protect people from motorized gate systems. UL325 requires that the type of entrapment protection correctly matches each gate application. Below are the six types of entrapment protection systems recognized by UL325 for use on this operator.

### ENTRAPMENT PROTECTION TYPES

Type A: Inherent obstruction sensing system, self-contained within the operator. This system must sense and initiate the reverse of the gate within two seconds of contact with a solid object.

Type B1: Connections provided for a non-contact device, such as a photoelectric eye can be used as a secondary protection.

Type B2: Connections provided for a contact sensor. A contact device such as a gate edge can be used for secondary protection.

Type C: Inherent adjustable clutch or pressure relief valve.

Type D: Connections provided for a control requiring continuous pressure to operate the operator open and close.

Type E: Built-in audio alarm. Examples include sirens, horns or buzzers.

**NOTE:** UL requires that all installations must have warning signs placed in plain view on both sides of the gate to warn pedestrians of the dangers of motorized gate systems.



## UL325 ENTRAPMENT PROTECTION REQUIREMENTS

### GATE OPERATOR ENTRAPMENT PROTECTION

UL325 Installation Class	Slide Gate Operator		Swing & Gate Barrier (Arm) Operator	
	Primary Type	Secondary Type	Primary Type	Secondary Type
Class I & II	A	B1, B2 or D	A or C	A, B1, B2, or C
Class III	A, B1 or B2	A, B1, B2, D or E	A, B1, B2 or C	A, B1, B2, C, D or E
Class IV	A, B1, B2 or D	A, B1, B2, D or E	A, B1, B2, C or D	A, B1, B2, C, D or E

The chart above illustrates the entrapment protection requirements for each of the four UL325 classes.

In order to complete a proper installation you must satisfy the entrapment protection chart shown above. That means that the installation must have one primary means of entrapment protection and one independent secondary means of entrapment protection. Both primary and secondary entrapment protection methods must be designed, arranged or configured to protect against entrapments in both the open and close directions of gate travel.

**For Example:** For a slide gate system that is installed on a single-family residence (UL325 Class I) you must provide the following: As your primary type of entrapment protection you must provide Type A inherent (built into the operator) entrapment sensing and at least one of the following as your secondary entrapment protection: Type B1- Non-contact sensors such as photoelectric eyes, Type B2- Contact sensors such as gate edges or Type D- Constant pressure control.

## **SAFETY INSTALLATION INFORMATION**

1. Vehicular gate systems provide convenience and security. Gate systems are comprised of many component parts. The gate operator is only one component. Each gate system is specifically designed for an individual application.
2. Gate operating system designers, installers and users must take into account the possible hazards associated with each individual application. Improperly designed, installed or maintained systems can create risks for the user as well as the bystander. Gate systems design and installation must reduce public exposure to potential hazards.
3. A gate operator can create high levels of force in its function as a component part of a gate system. Therefore, safety features must be incorporated into every design. Specific safety features include:
  - Gate Edges
  - Guards for Exposed Rollers
  - Photoelectric Sensors
  - Screen Mesh
  - Vertical Posts
  - Instructional and Precautionary Signage
4. Install the gate operator only when:
  - a. The operator is appropriate for the construction and the usage class of the gate.
  - b. All openings of a horizontal slide gate are guarded or screened from the bottom of the gate to a minimum of 4' (1.2 m) above the ground to prevent a 2 1/4" (6 cm) diameter sphere from passing through the openings anywhere in the gate, and in that portion of the adjacent fence that the gate covers in the open position.
  - c. All exposed pinch points are eliminated or guarded, and guarding is supplied for exposed rollers.
5. The operator is intended for installation only on gates used for vehicles. Pedestrians must be supplied with a separate access opening. The pedestrian access opening shall be designed to promote pedestrian usage. Locate the gate such that persons will not come in contact with the vehicular gate during the entire path of travel of the vehicular gate.
6. The gate must be installed in a location so that enough clearance is supplied between the gate and adjacent structures when opening and closing to reduce the risk of entrapment. Swinging gates shall not open into public access areas.
7. The gate must be properly installed and work freely in both directions prior to the installation of the gate operator.
8. Controls intended for user activation must be located at least six feet (6') away from any moving part of the gate and where the user is prevented from reaching over, under, around or through the gate to operate the controls. Outdoor or easily accessible controls shall have a security feature to prevent unauthorized use.
9. The Stop and/or Reset (if provided separately) must be located in the line-of-sight of the gate. Activation of the reset control shall not cause the operator to start.
10. A minimum of two (2) WARNING SIGNS shall be installed, one on each side of the gate where easily visible.
11. For a gate operator utilizing a non-contact sensor:
  - a. Reference owner's manual regarding placement of non-contact sensor for each type of application.
  - b. Care shall be exercised to reduce the risk of nuisance tripping, such as when a vehicle trips the sensor while the gate is still moving.
  - c. One or more non-contact sensors shall be located where the risk of entrapment or obstruction exists, such as the perimeter reachable by a moving gate or barrier.
12. For a gate operator utilizing a contact sensor such as an edge sensor:
  - a. One or more contact sensors shall be located where the risk of entrapment or obstruction exists, such as at the leading edge, trailing edge and post mounted both inside and outside of a vehicular horizontal slide gate.
  - b. One or more contact sensors shall be located at the bottom edge of a vehicular vertical lift gate.
  - c. A hard wired contact sensor shall be located and its wiring arranged so the communication between the sensor and the gate operator is not subject to mechanical damage.
  - d. A wireless contact sensor such as the one that transmits radio frequency (RF) signals to the gate operator for entrapment protection functions shall be located where the transmission of the signals are not obstructed or impeded by building structures, natural landscaping or similar obstruction. A wireless contact sensor shall function under the intended end-use conditions.
  - e. One or more contact sensors shall be located on the inside and outside leading edge of a swing gate. Additionally, if the bottom edge of a swing gate is greater than 6" (152 mm) above the ground at any point in its arc of travel, one or more contact sensors shall be located on the bottom edge.
  - f. One or more contact sensors shall be located at the bottom edge of a vertical barrier (arm).

## RECOMMENDED SITE LAYOUT EXAMPLE

Please use all safety devices that may apply to your installation to achieve the safest operation. (This is a view from above gate.)

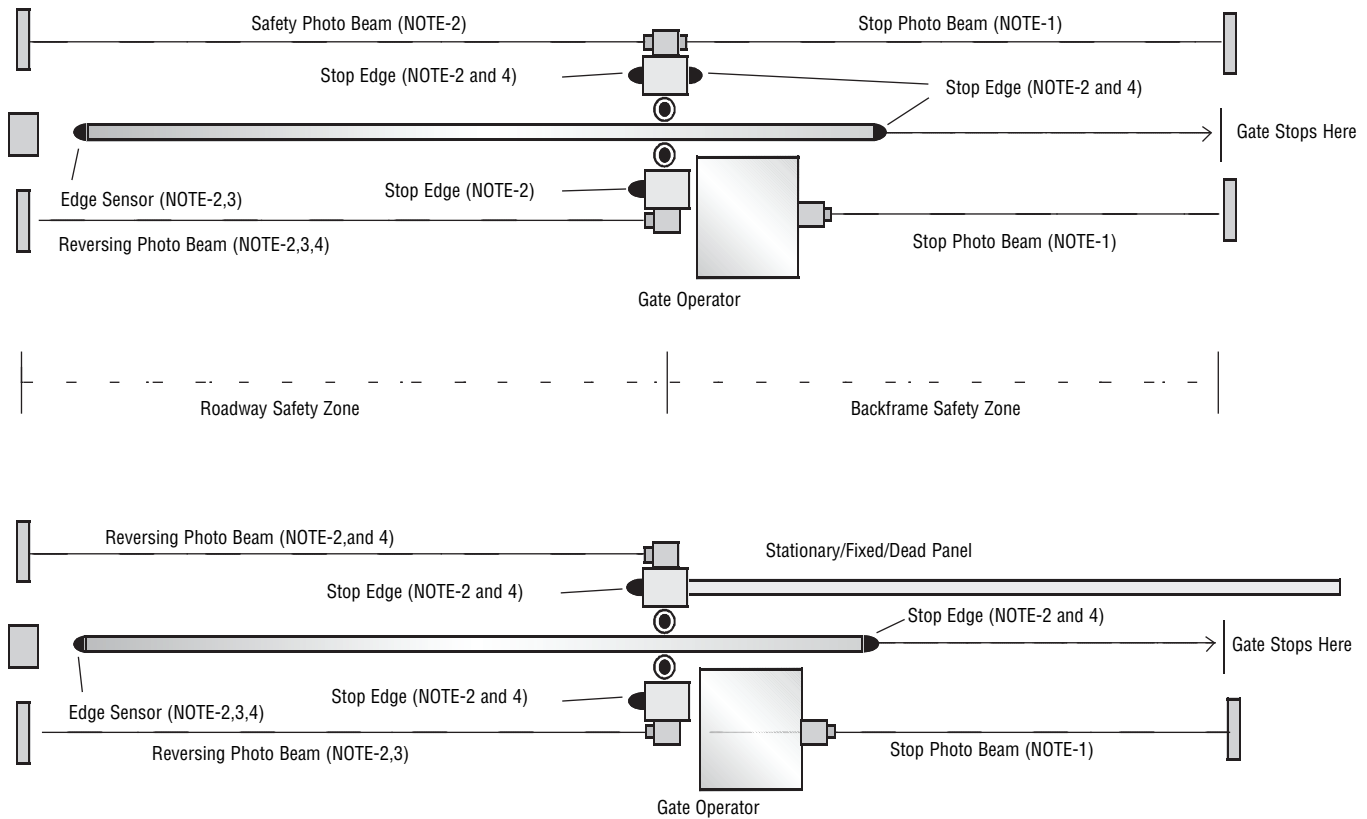

◀ = Contact Edges

*This drawing is not to scale.*

- NOTE-1: (Required) Secondary entrapment device (UL-325)
- NOTE-2: May be added as a third level of safety but is not to replace beams marked NOTE-1
- NOTE-3: Reversing edge or beam will re-open a closing gate (use J5 #5)
- NOTE-4: Stop edge will stop gate while contacted (use JP2 connection)

**NOTE:** This unit to employ:  
 Primary entrapment is an "A1" inherent entrapment sensing system with an audio alarm (reverses gate direction). Secondary entrapment is a "B1" a non-contact, photoelectric beam, connect at JP2 (stops gate, see NOTE-1). Use only UL recognized sensors. At least one secondary "stop" photo beam should be installed along the gate's path that is covered when open. Photo beams are to be installed according to their manufacturer's instructions and are to be placed in areas that pose a risk of entrapment. A separate pedestrian door is required per UL-325.

**It is recommended that all gates and operators be installed to conform to that latest ASTM F2200-02 requirements.**

## SAFETY PRECAUTIONS FOR OPEN ROLLER GATES

### **⚠ WARNING**

- Injuries occur when people get their hands or feet caught between the top or bottom of the gate and the gate roller. These potential pinch-points should be guarded against at ALL times. Enclosed style gate tracks are available for refitting of these rollers from many fence suppliers. Also, roller guards are available for installing over the rollers.
- UL325 requires that, when used, contact sensors shall be located at the leading edge, trailing edge, and be post mounted both inside and outside of a vehicular horizontal slide gate. Non-contact sensors such as photo eyes must protect during both open and close gate cycles.
- Injuries occur when people put their hands and arms through openings in the grill while the gate is operating. They cannot retract their arm and it gets caught between the moving gate grill and the stationary fence post or fence. This potential hazard can be averted by placing a 4' (1.2 m) screen mesh on the gate to prevent access through openings anywhere the gate may travel. See Safety Brochure for details. To prevent entrapment injuries, mount controls at least 6' (1.8 m) from the gate or ANY moving parts of the gate.

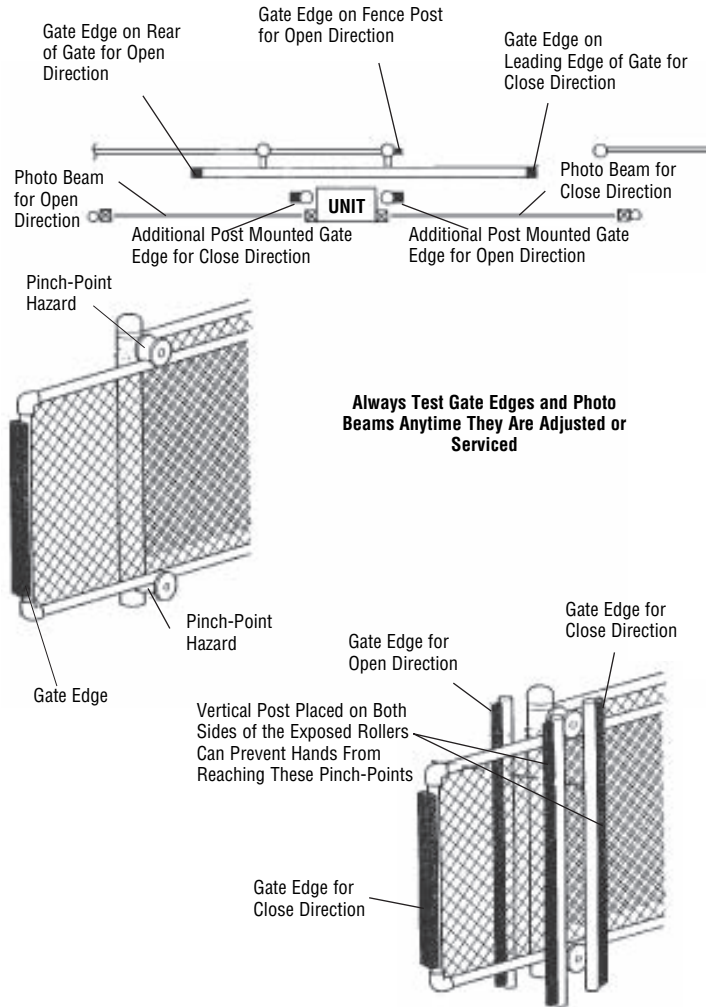

**Always Test Gate Edges and Photo Beams Anytime They Are Adjusted or Serviced**

**DO NOT MOUNT ACCESSORIES THAT ARE ACCESSIBLE THROUGH GATE!**

### **WARNING SIGN PLACEMENT**

### **⚠ WARNING**

- To prevent **SERIOUS INJURY** or **DEATH** from a moving gate:
- Install Warning signs on **EACH** side of gate in **PLAIN VIEW**.
  - Permanently secure each Warning sign in a suitable manner using fastening holes.

**NOT FOR USE AS PEDESTRIAN PASSAGE!** This operator is intended for vehicular use only. To prevent **INJURY** to pedestrians, a separate pedestrian access should be supplied, visible from the gate. Locate the pedestrian access where there is not a chance of **INJURY** at any point during full movement of the gate.

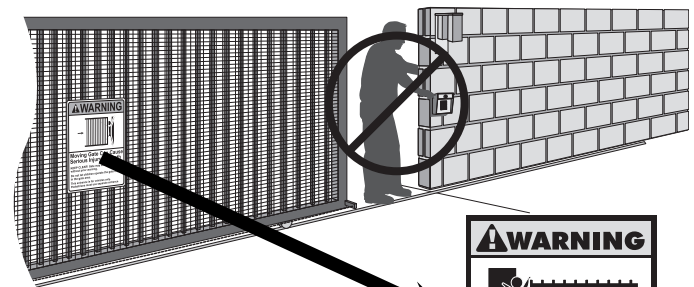
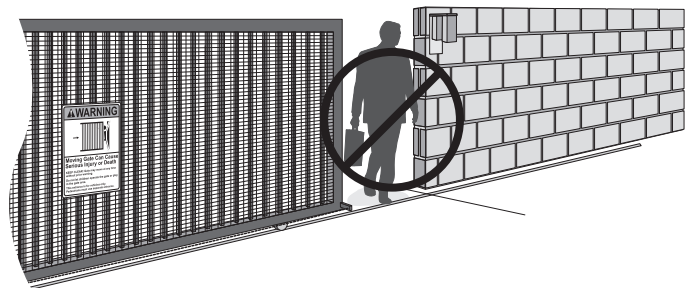

## **OPERATOR OVERVIEW**

The LiftMaster model MEGA SLIDE X slide gate operator is unique in the industry. Setting the MEGA SLIDE X apart are many features that make it the front runner in its class. With standard features like:

- Built in battery run - inherent 24 Vdc backup power with regulated 24 Vdc for accessories.
- High torque 1/2 HP 24 volt Permanent Magnet DC motor.
- Full service controller with eight inputs and LED indicators for loops, card reader, radio, etc.
- Continuous duty operation for most types of gates.
- Reversible gate direction for right or left handed operation.
- Instant Reverse Device (**IRD**) monitor senses obstructions going open and close.
- Automatic open of gate when ac power is lost if desired (with 15 second delay selection).
- ANTI-TAIL GATE with QUICK CLOSE feature STOP gate in close travel if tail-gating is sensed.
- Upon complete system failure (lightning, surges, etc.) gate can be pushed open by hand.
- All rust proof aluminum construction with baked on powder coat enamel.
- Molded Polyethylene UV stabilized cover never needs wax or paint.
- Direct drive gear reducer eliminates many parts that might otherwise fail.
- State of the art MOSFET motor drive technology, NO contactors or relays.
- Dynamic motor braking to preserve gate stopping points.
- Soft start and stop in open and close travel motions.
- High reliability micro switches actuate through nylon limit nuts on a precision ground shaft.
- Maximum Run Timer for motor (MRT) with anti-tamper protection in closing direction.
- Each unit configurable as master or second operator.
- Safe 24 Vdc low voltage motor and control wiring.
- LED diagnostics for easy trouble shooting.
- Closing timer adjustable from 1-31 seconds with on/off selection.
- Transient voltage protection on all inputs.
- Capable of being powered from 120 or 230 Vac, or UL Listed Class 2 Solar Power.
- On 120 Vac installations, unswitched duplex outlet gives convenient supply for 120 Vac accessories.
- Maximum weight of **1000 lbs**. Maximum length of **30'**. (Free moving operation)
- **10** year perforation warranty on cover and chassis with **2** years on electronics and mechanism.
- Input for safety edge device to reduce the possibility of entrapment – recommended.
- Input for non-contact sensing device (photo beam) for secondary entrapment protection.
- **UL Listed** device. (Standards by UL are UL-325, UL-991)

# INSTALLATION

## CONCRETE PAD

The concrete pad for operator mounting should be approximately 24" x 24" x 24" in order to provide adequate weight and structure to insure proper and stable operation. Pad should be 6" above finished grade (street level) or 6" above top of curb if one is present. Be sure to position pad so that it is not so close that it will interfere with the wheel mounting/axle bolts on the gate or that it is so far away that the rear mounting holes in the base will be too close to the edge of the concrete form.

**NOTE:** Pad must always extend below the frost line in areas where the ground freezes.

## ANCHORS

Proper anchors for fastening operator to pad will be a 1/2" x 6" wedge anchor patterned to match the mounting base of the unit. They should be installed with approximately 1" showing above concrete surface in order to allow for the 1/4" thick base plate as well as washers for leveling. Mounting hole pattern is 15 3/4" wide by 6 3/4" deep. The rear mounting hole centers (nearest to gate) will need to be between 6 1/4" and 7" from gate if the chain brackets that are provided are to be used (based on a gate with a 2" x 2" box tubing frame).

## CONDUITS

Use the open area in base of the unit to position your conduits. (12.0" wide by 10.75" deep). Use 1/2 or 3/4 inch UL listed conduits. Please observe any requirements in your local electrical code.

**NOTE:** Do not attempt to hook up the ac power if wires are LIVE or HOT. Be sure power is off.

## CHAIN INSTALLATION

Before beginning to install the chain, be sure that the centerline of the mounting holes in the chain brackets are 8 3/8" above the mounting pad. Once the brackets have been installed and the mounting holes in the brackets line up with the bottom of idler pulleys, connect one end of the chain to one end of the gate. Next thread the chain through the idlers and drive sprocket, then attach it to the other end of the gate. Cut chain so that the chain tensioners will not be adjusted out, allowing for as much future tightening as possible.

**NOTE:** Please allow 1" of droop (slack) for every 10' of chain.

## SAFETY EDGE INSTALLATION

See safety page in front of manual

It is highly recommended that a pressure sensing edge (safety edge) be installed at the leading edge and at all hazard and pinch points of the gate. Choose an edge that will cover the full height of the gate. It should be installed securely and any coil cord used to send the signal back to the operator should be cut so that excess cord be eliminated to prevent it from getting tangled in the gate or mechanism. Edges that are to REVERSE and re-open a closing gate connect to J5 #5 and #9 - #12. Edges that are to STOP the gate that is opening or closing will connect to the 2 pins on the JP2 block near the center of the board.

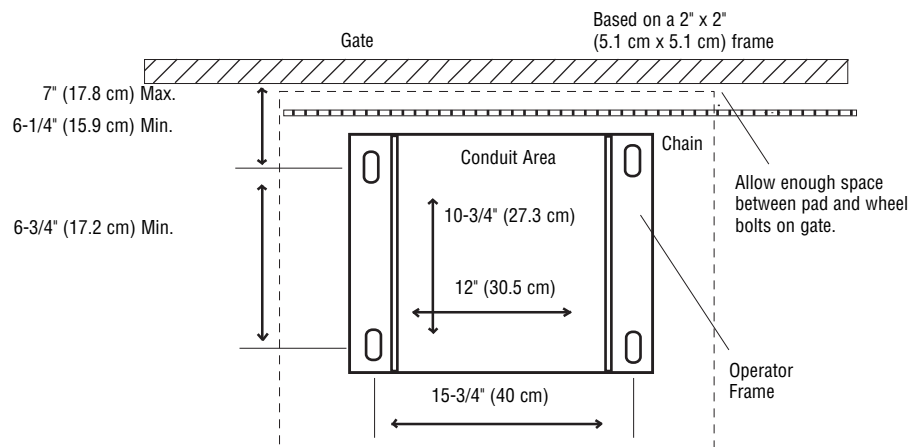

# WIRING AND HOOKUP

## WARNING

To reduce the risk of SEVERE INJURY or DEATH:

- ANY maintenance to the operator or in the area near the operator MUST not be performed until disconnecting the electrical power and locking-out the power via the operator power switch. Upon completion of maintenance the area MUST be cleared and secured, at that time the unit may be returned to service.
- Disconnecting power at the fuse box BEFORE proceeding. Operator MUST be properly grounded and connected in accordance with local electrical codes. **NOTE:** *The operator should be on a separate fused line of adequate capacity.*
- ALL electrical connections MUST be made by a qualified individual.

- DO NOT install ANY wiring or attempt to run the operator without consulting the wiring diagram. We recommend that you Install an optional reversing edge BEFORE proceeding with the control station installation.
- ALL power wiring should be on a dedicated circuit and well protected. The location of the power disconnect should be visible and clearly labeled.
- ALL power and control wiring MUST be run in separate conduit.
- BEFORE installing power wiring or control stations be sure to follow ALL specifications and warnings described below. Failure to do so may result in SEVERE INJURY to persons and/or damage to operator.

### AC POWER HOOKUP (120/230 Vac)

Be sure your main power is OFF before attempting to hook up the ac power. The ac wiring should be attached to the wires exiting the conduit or pedestal post. Only use UL approved 14AWG (or larger) 600 volt insulated wire. **NOTE:** *Do not connect any of the ac power wires directly to the electronic control board. Connect the batteries after the ac power is restored.*

#### 120 Vac

Connect the BLACK wire to the incoming 120 Vac hot lead and connect the WHITE wire to the incoming neutral lead. Connect the GREEN wire to the ground.

#### 230 Vac

Please purchase the 120 to 230 Vac conversion kit for 230 Vac operation. See Accessory page.

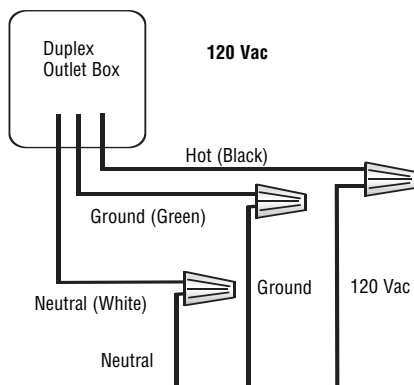

## INPUT COMMANDS CONNECTIONS

(Use common and normally open contacts from devices connected to these inputs)

### JP2 Input

This input will stop the gate and activate the siren.

This input is for connection to wired contact edge sensors at pinch points and photo beams that run along either side the gate panel when in open position (if dead panel is present one beam should run along it).

### Input Commands - J5 Connector Block at top of Control Board

Control wire connections at low voltage terminal strip will be at the top of the electronic control board. Make connections to the appropriate points for the desired operation. Wires should be UL approved 600 volt rated and at least 18 awg. All external control devices must have normally open dry contacts. **DO NOT CONNECT ANY DEVICE WHICH WOULD DELIVER ANY VOLTAGE OF ANY KIND TO THESE TERMINALS.**

Terminals 9, 10, 11, 12 are the commons (0 Vdc) used to activate the following inputs.

**Terminals 1, 2, 3 Open** - These inputs will trigger gate open when pulsed or hold gate open with maintained contact. When released gate will close if closing timer is on or if close input is given.

**Terminal 4, Auxiliary Open** - This is the wired line of sight, intended manual reset input. Use this input to reset the unit after a 2nd sequential obstruction is sensed and gate is locked with siren running. This input normally functions as listed below.

Acts same as 1, 2, 3 above with S2-6 off. With S2-6 ON this will operate as a pulse-open, pulse-close.

**NOTE:** Pulse to close will only work when gate is at full open position.

SIREN will run for 5 minutes after **2nd sequential obstruction**, then turns itself off, however operator will require a reset signal to J5 #4 to re-activate gate. In addition, cycling the ac power will also reset unit.

**Terminal 5, Safety** - Safety edge(s) and safety loop input. This function will make the gate reverse and go back to the open position if it was closing. Input is for all NORMALLY OPEN contact safety devices. This input is disabled when gate is in the full closed position. Use with vehicle loops, photo beams and sensors.

**Terminal 6, Close** - ANTI-TAIL GATE close input. When using a vehicle detector, you must use the presence contacts (N.O. and C.) This input will QUICK close gate after input is applied and then removed. It will stop the open cycle and reverse gate to close. (Example: Car crosses over close loop before gate reaches full open position – gate will reverse and close).

**NOTE:** The close input also acts as a safety-stop in that if gate is closing and a tail-gater is sensed at the close input, the gate WILL STOP its closing motion and not continue to close until the close input is removed or gate is re-opened.

**Terminal 7, Back-Away (For Barrier Arm Gate Only)** - This input is recommended for use with our Mega Arm barrier gates. For your Mega Slide X, please use terminals 1, 2 or 3 for your free exit loop input.

**Terminal 8, Shadow Loop** - This input operates as a hold open only when gate is a full open position.

**Terminals 9, 10, 11, 12 Common** - These inputs used for common (0 Vdc) to above listed functions.

**NOTE:** J5 inputs 1-8 are tied to LED indicators to assist in trouble shooting.

**3-Button Control Station** - Not already in place. See diagram below.

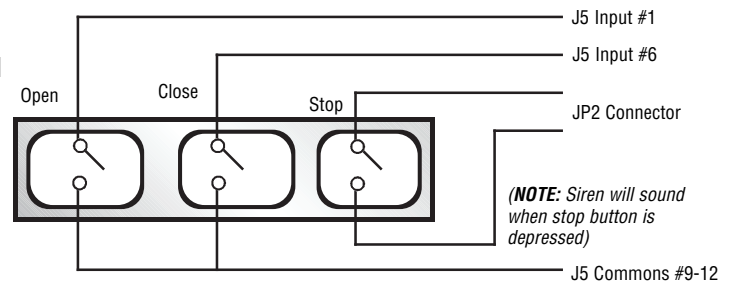

## ACCESSORY CONNECTIONS

These terminals will provide battery backed power to 24 Vdc devices and are located at the bottom of the electronic control board at J4 terminals 1 and 2. Terminal 1 is 24 Vdc (+) and number 2 is 0 Vdc (-). Peripheral CLASS 2 low voltage devices that require 24 Vdc power maybe connected here (500 ma. maximum). EXAMPLE: Vehicle detector, radio receiver.

**RELAY OUTPUT K1:** For class 1 and 2 installations, do not disconnect siren. S1-6 must be on and S1-8 must be off.

## BATTERY INSTALLATION

**HOOKING UP BATTERY LEADS:** Always hookup and turn on ac power before installing batteries. After turning on ac power, install two NEW, fully charged 12 volt dc batteries on shelf next to motor. Connect red lead from operator to the positive (RED +) terminal of one battery and black lead from the operator to the (BLACK-) terminal of the OTHER battery. Place a jumper between the remaining terminals of each battery if one is not already in place (Figure 1).

## MASTER/SECOND WIRING

### Master/second wire hook up:

1. In a master/second configuration, either unit can be the master. Choose one unit to be the master and then direct all control wiring to it (also install vehicle detectors and radio receivers this unit)
2. At the MASTER, any input (at J5) with control (detectors, receivers, keypads, timers, etc.) wires to it must also be run to the same terminals of the second.

Along with these control wires, both operators MUST share a common ground connection from chassis to chassis (or from PCB common to PCB common (Ex: master gate J5 terminal #12 to second gate J5 terminal #12)

EXAMPLE: If only open and close are used at master then three wires will run between gates (Figure 2). **More may be needed for additional functions to be used.**

3. If it is required that if one gate senses an obstruction, the other reverses also, then 3 additional wires must be run between the master J3 and second J3 (Figure 3). These connections are for transmitting IRD (obstruction signals) between both units. This will allow the master or second to inform the other that a closing obstruction has occurred and for it to reverse and open. **SET** switches on **S2, 1-8** the same on both gates.

FIGURE 1

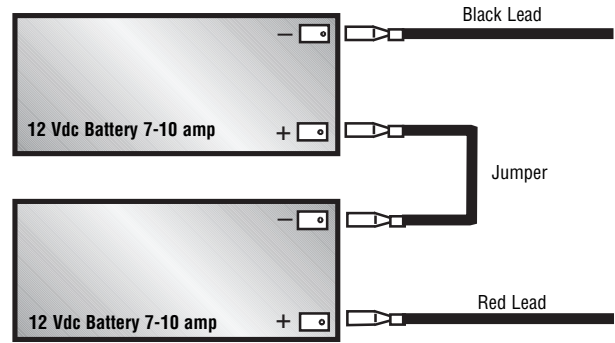

Failure to install batteries correctly will cause damage and will not be covered by warranty.

FIGURE 2

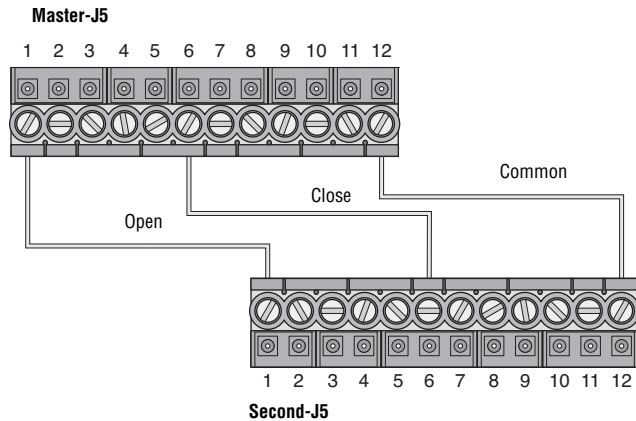
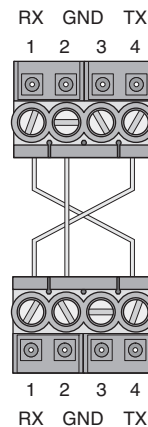

FIGURE 3



Master-J3

**IRD - Obstruction Signal Connections** Terminal 1 of Master must go to terminal 4 of Second and terminal 1 of Second must go to terminal 4 of Master. Terminal 2 of Master must go to terminal 2 of Second.

Second-J3

# TIMERS AND MODE SELECTIONS S1 & S2

## FAST RUN TIMER - SWITCH PACK S1 (1-5)

To change the FAST SPEED run timer, set the dip switches to add up to the number of feet, minus one foot, for the total feet of travel across roadway.

Example: If road is 15' wide, then set dip switches to add up to 14 seconds (dips 2, 3, 4 are on) which is 2 seconds + 4 seconds + 8 seconds = 14 seconds. You must set FULL SPEED to end before the end of travel and allow the gate to go to the slow speed before stopping.

Verify that the FAST SPEED run timer setting slowed down the gate approximately 1' from the end of travel. If it does not, adjust the dip switches appropriately.

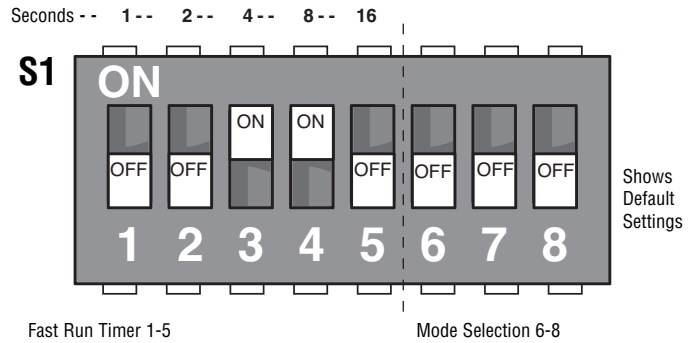

## MODE SELECTIONS - SWITCH PACK S1 (6-8)

**SWITCH 6:** FAIL SECURE MODE, (VER 6.351 or higher) with ac power off, in continuous battery back up mode (S2 #8 off) gate will not auto open if batteries get low. If batteries are low, gate will stay open after an open command is given.

**SWITCH 7:** No longer used as of August 16, 2003. To be redefined.

**SWITCH 8:** Not used at this time (VER 6.34 or higher only).

## CLOSE TIMER - SWITCH PACK S2 (1-5)

On the MEGA SLIDE X the switches 1-5 on S2 are for the closing timer delay. If S2-7 is on, the gate will auto close by timer. Default is S2-3 "on" to provide a 4 second delay if activated.

## MODE SELECTIONS - SWITCH PACK S2 (6-8)

**SWITCH 6:** Sets auxiliary open input terminal #4 at J5 to be **pulse open--pulse close** (example: residential applications).

**SWITCH 7 - AUTO CLOSE TIMER:** Default is **OFF**. When on, use S2 1-5 to set close time delay.

When close timer is selected, **YOU** must install vehicle and pedestrian detection devices. It is strongly recommended that photoelectric beams (eyes) be installed on **BOTH** sides of the slide gate to reduce the possibility of injury to persons that may attempt to walk through gate opening. Along with the beams, it is strongly recommended that pressure sensing edges be installed on the leading edge of the gate panel, and any area that presents a **PINCH POINT** or risk of **ENTRAPMENT**.

**SWITCH 8 - AUTO OPEN ON AC POWER FAILURE:** When switch number 8 is in the **ON** position, the operator will automatically open the gate approximately 15 seconds after the loss of power. Once ac power is restored, the operator will resume normal operation.

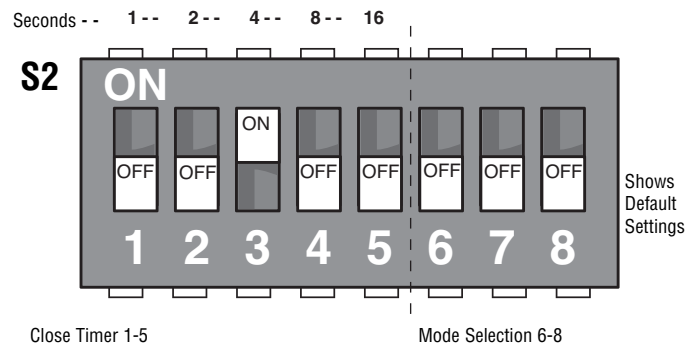
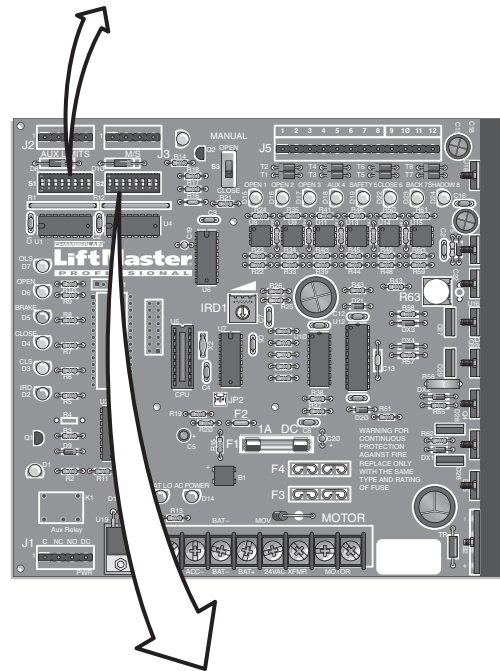

# ADJUSTMENTS

## RIGHT OR LEFT HAND OPERATION UNIT SHIPS AS RIGHT-HAND

**Method 1:** No longer used as of August 16, 2003. The S1-7 switch will be redefined.

**Method 2:** Reverse the BLUE and ORANGE wire from the motor and at J4 from the limit switches. With this method DO NOT switch S1-7 to the ON position – leave in OFF position.

**RIGHT HAND OPERATION** the motor (J4) and limit switch (J2) wires will be **BLUE** then **ORANGE**

**NOTE:** Right hand operation is the default setting from the factory.

**LEFT HAND OPERATION** the motor (J4) and limit wires (at J2) will be **ORANGE** then **BLUE**.

As a **RIGHT HAND OPERATOR** the **LIMIT SWITCH** closest to the gear box is the **CLOSE LIMIT**.

As a **LEFT HAND OPERATOR** the **LIMIT SWITCH** closest to the gear box is the **OPEN LIMIT**.

## LIMIT SWITCH ADJUSTMENTS

Disconnect power from operator. In order to adjust limit nuts, the detent plate must be pushed down to allow free movement. Spinning the nut closer to the switch will cause the gate to stop sooner when approaching that switch. Spinning it away will delay the nut in reaching that switch. With power disconnected, (batteries and ac power) gate can be pushed open and closed to assist in limit switch adjustments. After initial settings connect power then run gate open and close to fine tune settings.

Remember to set the fast run timer (page 13) to allow gate to run at the fast speed for as much of the gate travel as possible, but still ensuring that it will slow down just before reaching the closed position.

## INSTANT REVERSE DEVICE (IRD)

The reverse device is an internal circuit that continuously monitors the motor's current for increased draw. This operator has been shipped with the IRD1 set to a typical setting that will likely move the gate from limit to limit. If necessary, the sensitivity of this device can be adjusted by turning the IRD1 to the right (CW, more sensitive) or left (CCW, less sensitive) in small increments.

### ADJUSTMENT

While running the gate open and closed, verify that the gate travels as expected. Verify that the operator reverses off a rigid obstruction located 1' from both the open and close limit. If the operator does not reverse, adjust the IRD1 CW (more sensitive) in small, 1 hour increments until the gate reverses off the 1' obstruction. The gate should continue to travel from the open and closed limits as expected.

If the gate did not complete the full open and closed travel, the IRD1 setting should be incremented CCW (less sensitive) in small, 1 hour increments until the gate travels the full distance. Verify that the operator reverses off a rigid obstruction located 1' from both the open and closed limit.

Seasonal ambient temperature changes may make IRD1 adjustments necessary. If during the setup, a double entrapment condition occurs, refer to the troubleshooting section to rest the gate.

### RIGHT HAND OPERATION

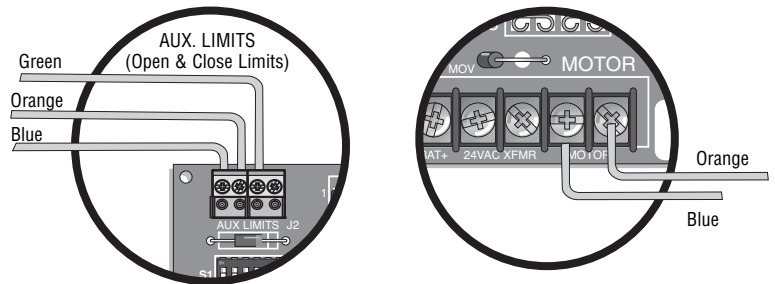

OR

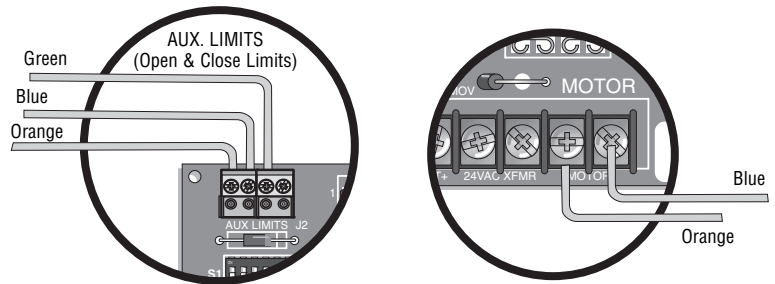

### LEFT HAND OPERATION

### RIGHT HAND OPERATION

**NOTE:** Unit ships out as a right hand (default wiring setup).

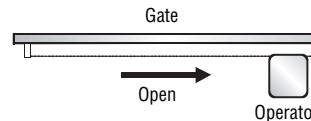

Righthand operation is viewed from the same side of the gate as the operator with the operator to your right.

## WARNING

To prevent possible **SERIOUS INJURY** or **DEATH**:

- After ANY adjustments, verify that the operator reverses off a rigid obstruction located 1' from both the open and close limits.
- Test instant reverse device (IRD) monthly.
- Adjustment **MUST** be made by qualified service personnel.



# RECEIVER

## WARNING

To prevent possible **SERIOUS INJURY** or **DEATH** from a moving gate or garage door:

- ALWAYS keep remote controls out of reach of children. NEVER permit children to operate, or play with remote control transmitters.
- Activate gate or door **ONLY** when it can be seen clearly, is properly adjusted, and there are no obstructions to door travel.
- ALWAYS keep gate or garage door in sight until completely closed. NEVER permit anyone to cross path of moving gate or door.

### SET SECURITY MODE

The Universal Receiver can be used with up to 15 rolling code remotes or passwords in HIGH security mode. Alternately, it can be used with up to 31 of any type remote in NORMAL security mode, including any combination of rolling code, billion code, or dip switch remotes.

The jumper must be set at the HIGH position for the receiver to operate in HIGH security mode. It must be set at NORMAL position to operate at the NORMAL mode (Figure 1).

When changing from NORMAL to HIGH security mode, any previous remote codes must be erased. Repeat Steps 2 and 3 in the Programming Section below to reprogram the receiver for each remote control in use.

The receiver is factory set at HIGH.

### PROGRAMMING THE REMOTE TO THE RECEIVER

1. Pry open the front panel of receiver case with a coin or a screwdriver. Re-connect power to opener (Figure 2).
2. Press and release the “learn” button on the receiver. The learn indicator light will glow steadily for 30 seconds.
3. Within 30 seconds, press and hold the button on the hand-held remote that you wish to operate your gate.

The opener will now operate when the push button on either the receiver or the remote control is pressed.

Repeat Steps 2 and 3 for each remote control that will be used to operate the gate.

### TO ERASE ALL REMOTE CONTROL CODES

Press and hold the “learn” button on the receiver panel until the indicator light turns off (about 6 seconds). All remote codes are now erased. Then follow the steps above to reprogram each remote control.

NOTICE: To comply with FCC and or Industry Canada (IC) rules, adjustment or modifications of this receiver and/or transmitter are prohibited, except for changing the code setting or replacing the battery. THERE ARE NO OTHER USER SERVICEABLE PARTS.

Tested to Comply with FCC Standards FOR HOME OR OFFICE USE. Operation is subject to the following two conditions: (1) this device may not cause harmful interference, and (2) this device must accept any interference received, including interference that may cause undesired operation.

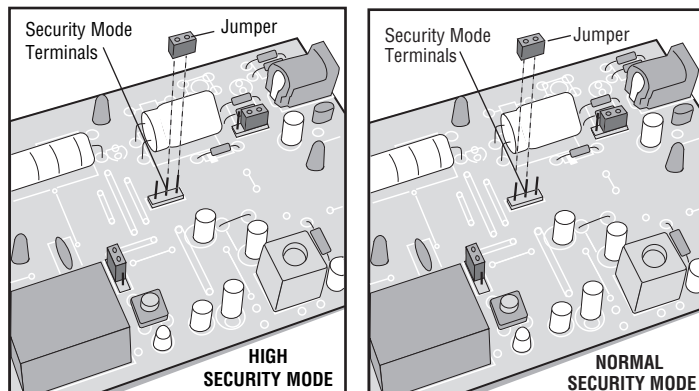

FIGURE 1

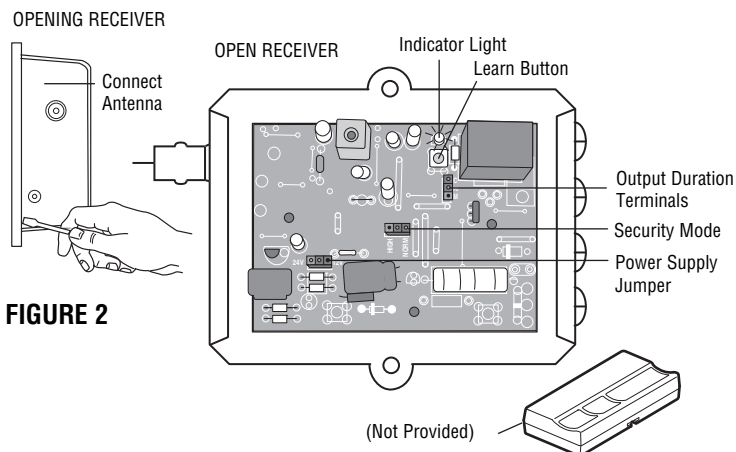

FIGURE 2

# OPERATION AND MAINTENANCE

Check at the intervals listed in the following chart:

ITEM	PROCEDURE	EVERY MONTH	EVERY 3 MONTHS	EVERY 6 MONTHS	EVERY 12 MONTHS	EVERY 24 MONTHS
Instant Reverse Devise (IRD)	Test IRD Reversal.	•				
Fasteners	Check and tighten as required.			•	◆	
Bearings & Shafts	Check for wear and lubricate.		•		◆	
Battery Maintenance	Replace batteries					•

◆ Repeat ALL procedures.

## GENERAL SERVICE

- Belt loose or needs replacement, adjust with 4 bolts that support motor to allow 1/4" play.
- Charge voltage for batteries should be 27.5 +0.05, -0 Vdc with batteries disconnected (Set with R63, shown on the Control Board Layout page).
- Replace batteries with LiftMaster P/N MBAT batteries. Replace in pairs.

## BATTERY DISPOSAL

Replaced batteries must be treated as a hazardous waste and disposed of in accordance with State, Local and Federal Regulations. See the battery manufacturer's Material Safety Data Sheets (01-30839 "MSDS Sheets, Battery, Standard").

## BATTERY REPLACEMENT

Service Kits are available for battery replacement. Please contact Technical Support (see back of this document for contact information).

## WARNING

To prevent possible SERIOUS INJURY or DEATH from electrocution or fire, BEFORE proceeding

- Disconnect ac power at the fuse box.
- Disconnect dc power at the battery connection.

## BATTERY MAINTENANCE / TESTING

The batteries are maintenance free. However, to insure proper and safe operation, it is recommended that the batteries be replaced every two years. Battery testing is conducted automatically. See the Battery Test Description section for manually initiating the battery test.

## BATTERY HANDLING / STORAGE

Refer to the battery manufacturer's Material Safety Data Sheets (01-30839 "MSDS Sheets, Battery, Standard"). LiftMaster does not recommend storage of batteries in the field. Batteries are intended for immediate use.

# TROUBLESHOOTING

## BATTERY CHECKOUT

When the batteries become weak the gate will begin to run noticeably slower. (**NOTE: Batteries should only be checked when you are sure they have had adequate time to fully charge.**) Turn off the ac power and run gate for 5 to 10 cycles while observing low battery indicator LED D12. If LED 12 comes ON, batteries are too weak to function properly. If LED 12 does not light, then voltage should be checked as they still may be near failure. Correct voltage is approximately 25.5 Vdc. (**NOTE: If LED D12 does light, gate will open to conserve batteries in this test or in a real power loss, even if mode switch 8 on S2 is off.**) Return of ac power will clear low battery indicator. Correct charge voltage is 27.5 Vdc with batteries not connected (Set with R63, shown on the Control Board Layout page).



## WARNING

To prevent possible **SERIOUS INJURY** or **DEATH** from electrocution or fire, **BEFORE** proceeding

- Disconnect ac power at the fuse box.
- Disconnect dc power at the battery connection.

## GATE NOT OPERATING

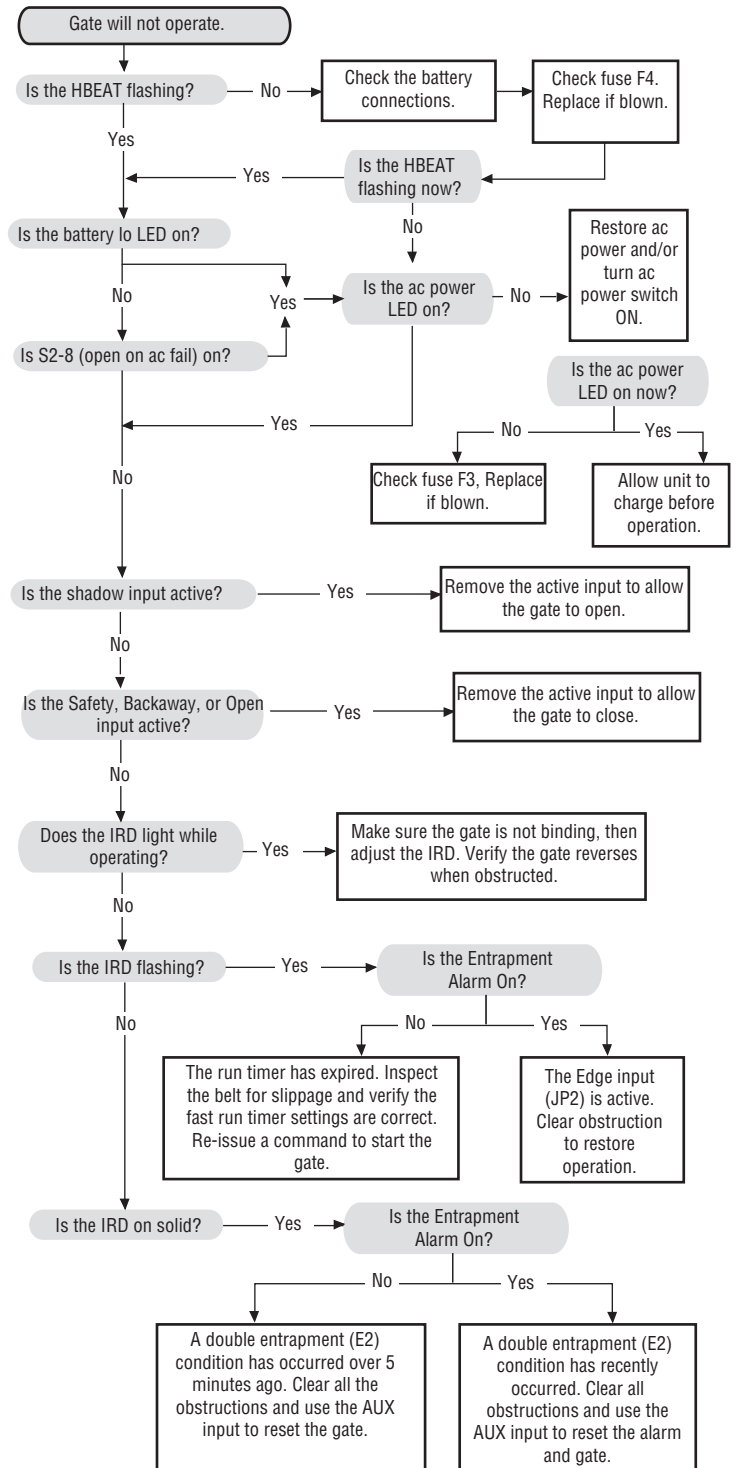

# SUGGESTED LOOP SENSOR LOCATIONS

## FREE EXIT ON VEHICLE APPROACH

Gate will open when sensed by open loop and then close once all loops are cleared if the close timer is on. Close input can be used to close gate before timer expires (Figure 1).

Terminal #1, 2, and 3 are open inputs.

Terminal #5 is safety input.

## ENTRY WITH ACCESS CONTROL DEVICE

Gate will open when activated by an access control device. When timer expires (if used), gate will close (Figure 2).

Terminal #5 is safety input.

Terminals #1, 2, and 3 are open inputs.

## DUAL DIRECTION AS ENTRY AND FREE EXIT

Dual direction is a combination of both of the above configurations to provide the ability for traffic to enter or exit in the same lane (Figure 3).

**RECOMMENDATION 1:** If vehicle detectors are used to open or close the gate, use of the presence contacts are recommended. Using the pulse contacts will **REDUCE** the gate's safe operation.

**RECOMMENDATION 2:** Use safety pressure sensing edges to prevent entrapment.

**RECOMMENDATION 3:** Install **ALL** access control devices within view of gate.

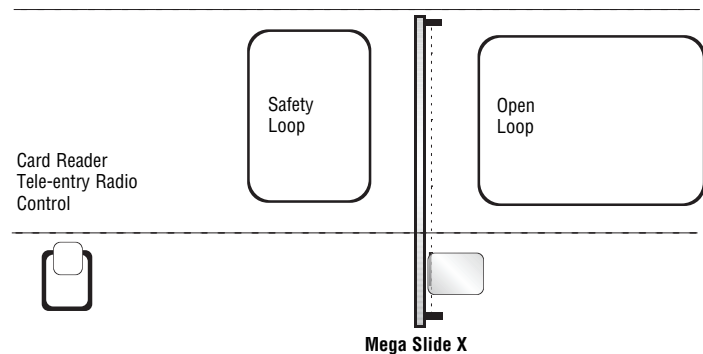
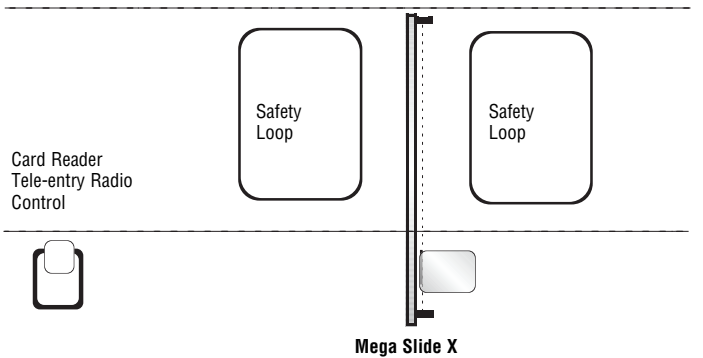
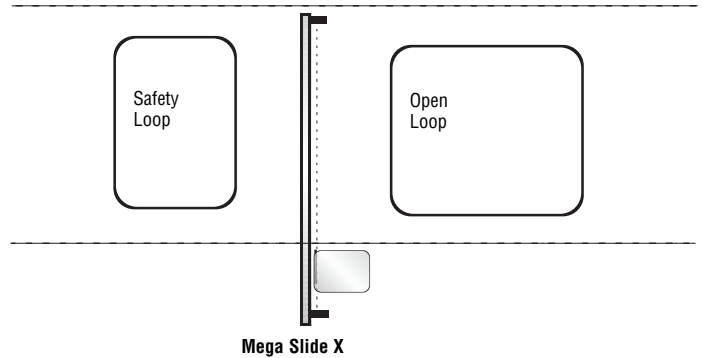

# CONTROL BOARD LAYOUT

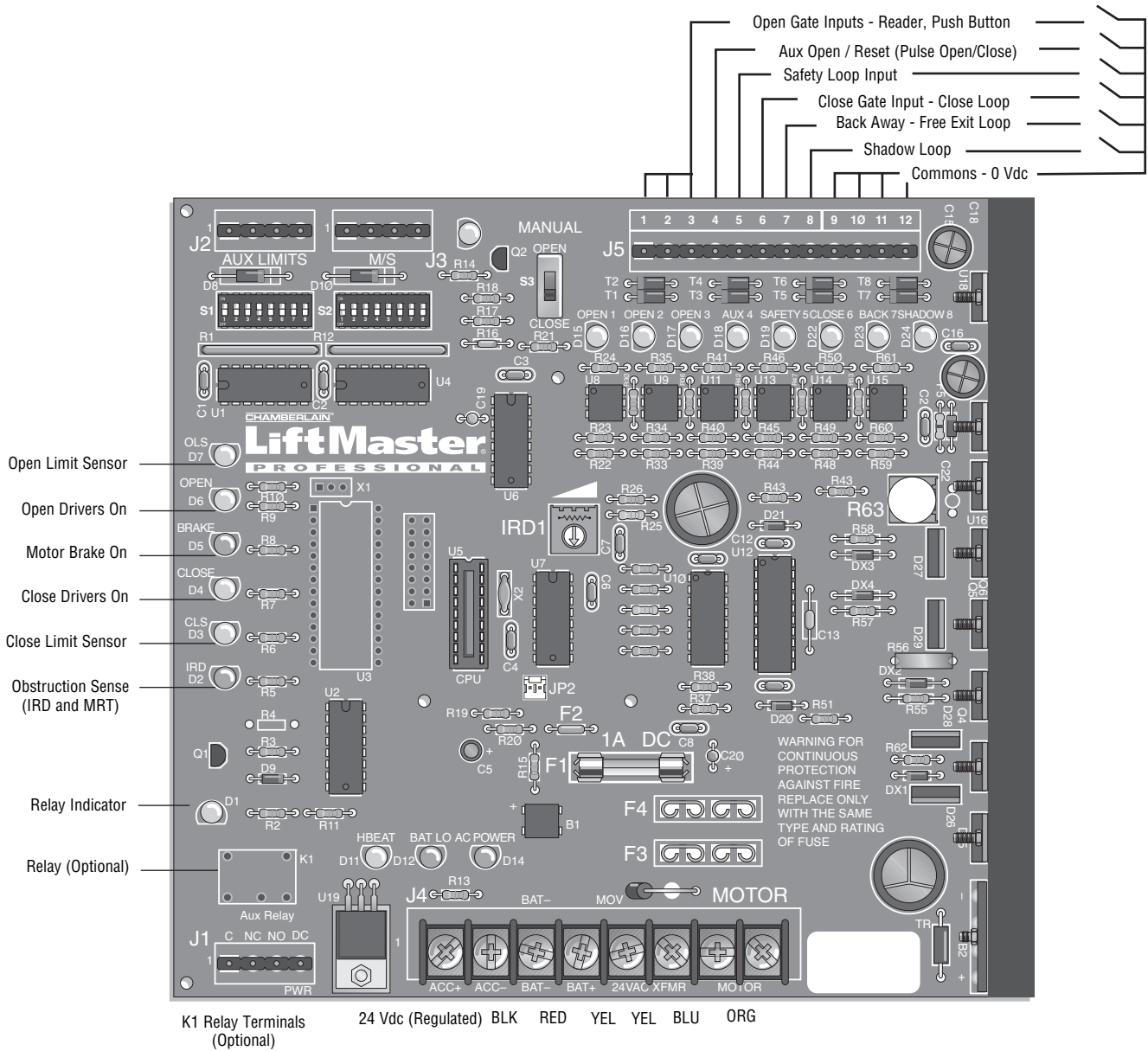

## COMPONENT LOCATIONS

Accessory power is 24 Vdc regulated rated at 500 ma. [1/2 amp].

**J5 #4** for use with hard wired line of sight devices to open gate and reset unit.

**D11:** Heart beat. Shows that processor and program routine are running properly.

**D12:** Battery status. See diagnostic procedures on page 17.

**D14:** AC power indicator. Shows that ac power is present.

**F3:** 15 amp ATO type fuse for 24 Vac input power. (UL listed fuse only.)

**F4:** 15 amp ATO type fuse for 24 Vdc battery input power. (UL listed fuse only.)

**JP2:** Input for photo beam used as secondary entrapment protection.

# REPAIR PARTS

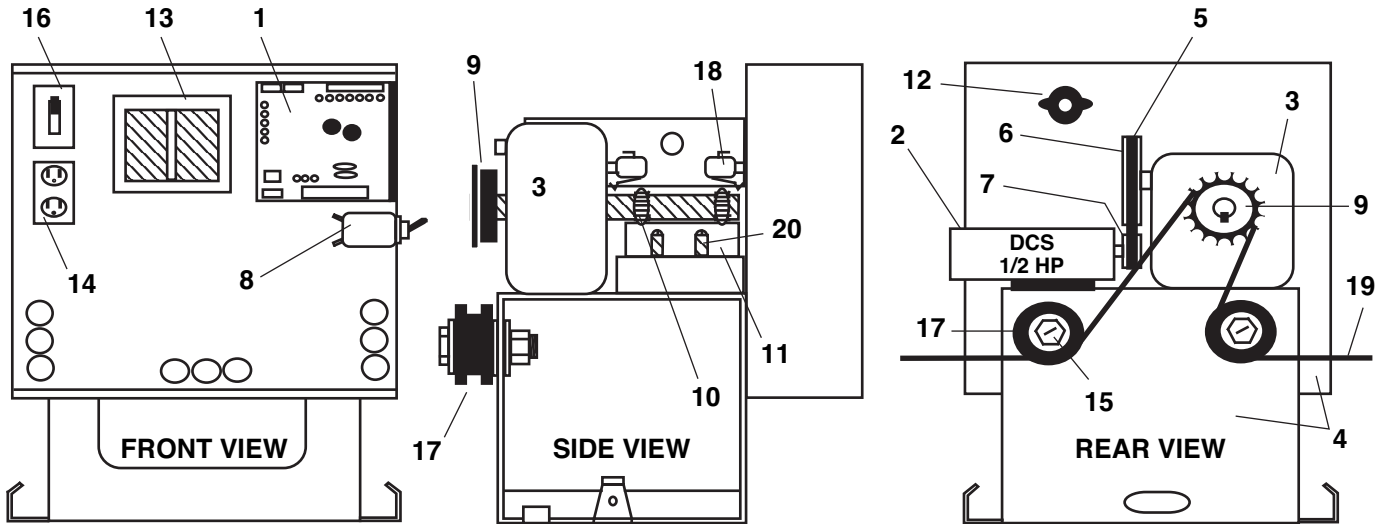

## INDIVIDUAL PARTS

ITEM	PART #	DESCRIPTION
1	MS001	Controller - CPU
2	MS003	1/2 HP High Torque Motor 24 Vdc
3	MS005	Gear Reducer 10:1
4	MS006X	1/4" Yellow Zinc Chassis (frame)
5	MS007	Drive Belt
6	MS010	Reducer Pulley 5"
7	MS009	Motor Pulley 2"
8	MS351	Motor Breaker/Disconnect
9	MS041	Drive Gear
10	MS043	Limit Nuts
11	MS013	Detent Plate
12	MS014	Siren (100 db)
13	MS015	Transformer (120/230 Vac - 24 Vac)
14	MS016	120 Vac Duplex Outlet (120 Vac Only)
15	MS018	Idler Pulley Bolt, Washer and Nut
16	MS019	120 Vac On/Off Switch
17	MS040	Idler Pulley (UHMW)
18	MS044	Limit Switch
19	MS202	#41 Nickel Plated Drive Chain (10' coils, 2 required)
20	MS206	Compression Spring for Detent Plate
		<b>NOT SHOWN</b>
*	73A3	Filter Module
*	K74-33888	Surge Suppressor
*	MS002	J5 Connector (on PCB)
*	MBAT	12 Vdc 7AH Battery 2 required (included)
*	MS017	Bolt and Nut (4) Reducer
*	MS021	Removable Accessory Shelf
*	MS023	Window, Limit Cover (with bend)
*	MS020X	Unit Cover

# ACCESSORIES

371LM

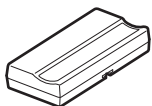

**Security+® Single Button Remote Control**:  
Includes visor clip.

A57

**Wiring Harness:** For the A24.

373LM



**Security+® 3-Button Remote Control**:  
Includes visor clip.

MA201

**Heater Option:** 150 watt with thermostat

374LM



**Security+® 4-Button Remote Control**:  
Includes visor clip.

MBAT

**Replacement Battery (1):**  
12V, 7Amp Battery 2 required per operator.

MA200

**K1 Relay Output Option:**  
Accessory relay for external signaling  
(common, N.C & N.O. contacts).

SAMSKIT

**Sequenced Access Management:**  
Includes required relay and limits.

CPT13



**Passport 1-Button Remote Control**:  
Includes visor clip.

MA230VKIT

**Voltage Conversion Kit:**  
Includes surge suppressor, wire jumper, duplex  
box covers and detailed instructions.

CPT33



**Passport 3-Button Remote Control**:  
Includes visor clip.

CPT43



**Passport 4-Button Remote Control**:  
Includes visor clip.

A24

**24 Vdc Loop Detector**

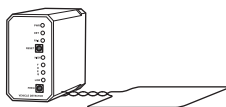

# SAFETY ACCESSORIES FOR SECONDARY ENTRAPMENT PROTECTION

The following devices are acceptable for Safety Accessories for secondary entrapment protection.

PHOTO-ELECTRIC CONTROLS		
MODEL	DESCRIPTION	VOLTAGE
E3K-R10K4-NR	OMRON/MMTC, Retro-reflective type	
60-2728	Allen-Bradley (with 2m cable), Retro-reflective type	
60-2729	Allen-Bradley (with 5 pin term), Retro-reflective type	
SENSING EDGES		
MODEL	DESCRIPTION	
ME-120	Miller Edge, Normally open contact	
ME-123	Miller Edge, Normally open contact	
MG-020	Miller Edge, Normally open contact	
MG020	Miller Edge, Normally open contact	
MGR20	Miller Edge, Normally open contact	
MGS20	Miller Edge, Normally open contact	

# REPAIR PARTS AND SERVICE

## HOW TO ORDER REPAIR PARTS

OUR LARGE SERVICE ORGANIZATION  
SPANS AMERICA

INSTALLATION AND SERVICE INFORMATION  
IS AS NEAR AS YOUR TELEPHONE. SIMPLY DIAL OUR  
TOLL FREE NUMBER:

**1-800-528-2806**

**[www.liftmaster.com](http://www.liftmaster.com)**

WHEN ORDERING REPAIR PARTS, ALWAYS GIVE  
THE FOLLOWING INFORMATION:

- PART NUMBER
- PART NAME
- MODEL NUMBER

ADDRESS ORDERS TO:  
THE CHAMBERLAIN GROUP, INC.  
Technical Support Group  
6020 S. Country Club Road  
Tucson, Arizona 85706

# LIMITED WARRANTY

## LIFTMASTER 2 YEAR LIMITED WARRANTY 10 YEAR CORROSION/PERFORATION LIMITED WARRANTY ON COVER AND CHASSIS

**The Chamberlain Group, Inc.** ("Seller") warrants to the first purchaser of this product, for the structure in which this product is originally installed, that it is free from defect in materials and/or workmanship for a period of 2 YEARS from the date of purchase [and that the COVER AND CHASSIS is free from defect in materials and/or workmanship for a period of 10 YEARS from the date of purchase]. The proper operation of this product is dependent on your compliance with the instructions regarding installation, operation, maintenance and testing. Failure to comply strictly with those instructions will void this limited warranty in its entirety.

If, during the limited warranty period, this product appears to contain a defect covered by this limited warranty, call 1-800-528-2806, toll free, before dismantling this product. Then send this product, pre-paid and insured, to our service center for warranty repair. You will be advised of shipping instructions when you call. Please include a brief description of the problem and a dated proof-of-purchase receipt with any product returned for warranty repair. Products returned to Seller for warranty repair, which upon receipt by Seller are confirmed to be defective and covered by this limited warranty, will be repaired or replaced (at Seller's sole option) at no cost to you and returned pre-paid. Defective parts will be repaired or replaced with new or factory-rebuilt parts at Seller's sole option.

**ALL IMPLIED WARRANTIES FOR THE PRODUCT, INCLUDING BUT NOT LIMITED TO ANY IMPLIED WARRANTIES OF MERCHANTABILITY AND FITNESS FOR A PARTICULAR PURPOSE, ARE LIMITED IN DURATION TO THE 2 YEAR LIMITED WARRANTY PERIOD SET FORTH ABOVE [EXCEPT THE IMPLIED WARRANTIES WITH RESPECT TO THE COVER AND CHASSIS, WHICH ARE LIMITED IN DURATION TO THE 10 YEAR LIMITED WARRANTY PERIOD FOR THE COVER AND CHASSIS, AND NO IMPLIED WARRANTIES WILL EXIST OR APPLY AFTER SUCH PERIOD. Some States do not allow limitations on how long an implied warranty lasts, so the above limitation may not apply to you. THIS LIMITED WARRANTY DOES NOT COVER NON-DEFECT DAMAGE, DAMAGE CAUSED BY IMPROPER INSTALLATION, OPERATION OR CARE (INCLUDING, BUT NOT LIMITED TO ABUSE, MISUSE, FAILURE TO PROVIDE REASONABLE AND NECESSARY MAINTENANCE, UNAUTHORIZED REPAIRS OR ANY ALTERATIONS TO THIS PRODUCT), LABOR CHARGES FOR REINSTALLING A REPAIRED OR REPLACED UNIT, OR REPLACEMENT OF BATTERIES.**

**THIS LIMITED WARRANTY DOES NOT COVER ANY PROBLEMS WITH, OR RELATING TO, THE GATE OR GATE HARDWARE, INCLUDING BUT NOT LIMITED TO THE GATE ALIGNMENT OR HINGES. THIS LIMITED WARRANTY ALSO DOES NOT COVER ANY PROBLEMS CAUSED BY INTERFERENCE. ANY SERVICE CALL THAT DETERMINES THE PROBLEM HAS BEEN CAUSED BY ANY OF THESE ITEMS COULD RESULT IN A FEE TO YOU.**

**UNDER NO CIRCUMSTANCES SHALL SELLER BE LIABLE FOR CONSEQUENTIAL, INCIDENTAL OR SPECIAL DAMAGES ARISING IN CONNECTION WITH USE, OR INABILITY TO USE, THIS PRODUCT. IN NO EVENT SHALL SELLER'S LIABILITY FOR BREACH OF WARRANTY, BREACH OF CONTRACT, NEGLIGENCE OR STRICT LIABILITY EXCEED THE COST OF THE PRODUCT COVERED HEREBY. NO PERSON IS AUTHORIZED TO ASSUME FOR US ANY OTHER LIABILITY IN CONNECTION WITH THE SALE OF THIS PRODUCT.**

Some states do not allow the exclusion or limitation of consequential, incidental or special damages, so the above limitation or exclusion may not apply to you. This limited warranty gives you specific legal rights, and you may also have other rights which vary from state to state.

## **INSTALLATION CHECK OFF LIST**

***This Slide Gate operator is installed for use in a Class \_\_\_\_\_ installation.***

***Each item on this installation check off list should be verified by the installer.***

- \_\_\_\_\_ Two warning signs securely installed on each side of gate panel (required).
- \_\_\_\_\_ 1 or 2 safety photo beams installed, one across each side of gate opening (required).
- \_\_\_\_\_ 1 or 2 stop photo beams installed on each side of fixed gate panel (required).
- \_\_\_\_\_ Customer advised that gate in for vehicular traffic only (required).
- \_\_\_\_\_ A separate pedestrian entry and/or exit is provided (required).
- \_\_\_\_\_ Contact edges installed and functional at all hazard or pinch points.
- \_\_\_\_\_ Safety guards installed covering all cantilever wheels (required).
- \_\_\_\_\_ All controls located far out of reach of gate, fixed panel and operator (required).
- \_\_\_\_\_ This class operator is approved for the application of the operator (1, 2, 3 or 4) (required).
- \_\_\_\_\_ A sphere with a 2-1/4" diameter cannot be pushed through the gate or fixed panel.
- \_\_\_\_\_ A safety screen/mesh is installed with a minimum height of 4' from ground.
- \_\_\_\_\_ Controls intended to reset gate after obstructed installed in line of sight (required).
- \_\_\_\_\_ Hard wired contact sensors located and wired to avoid any mechanical damage.
- \_\_\_\_\_ Customer instructed and is clear on proper use of gate operator (required).
- \_\_\_\_\_ Customer instructed on proper use of all control devices used with operator.
- \_\_\_\_\_ Safety instructions were reviewed and left with customer (required).
- \_\_\_\_\_ Installer offered a preventative service/maintenance contract.
- \_\_\_\_\_ A photo of completed installation taken from front and back of gate and dated.
- \_\_\_\_\_ Gate conforms to the recommended ASTM F 2200-02 requirements.

---

Customer's Signature

Date

---

Installer's Signature

Date

***Customer and installer should retain a copy of this check off list for their records.***