

THE 422 OPERATOR AND 455 D CONTROL PANEL: INSTALLATION MANUAL

CONTENTS

Important Safety Information	2
Technical Data	4
Unpacking the Operator	5
The 422 Compact Operator General Characteristics	6
Installation Instructions	6
Prepare the Gate	6
Manual Release Mechanism	7
Install the Operator	7
Install the 455 D Control Panel	9
Exploded View, 422 CBC	12
422 Parts List	13
The 455 D Control Panel Installation Instructions	
The 455 D Control Panel General Description	14
Installing the 455 D Control Panel	14
Connect the Main Power Supply	14
Connect the Operator to the Control Panel	15
Check the Motor's Direction of Rotation	15
Connect Other Devices	16
Set Other Operating Controls	18
Programming	20
Learning of Operating Times	22
Learning of Normal Times	22
Learning Times with Gatecoder	22
Automated Systems Test	23
Logic Tables of 455 D Control Panel	24
Maintenance	26
Safety in Gate Design	26
Troubleshooting	27
Limited Warranty	28

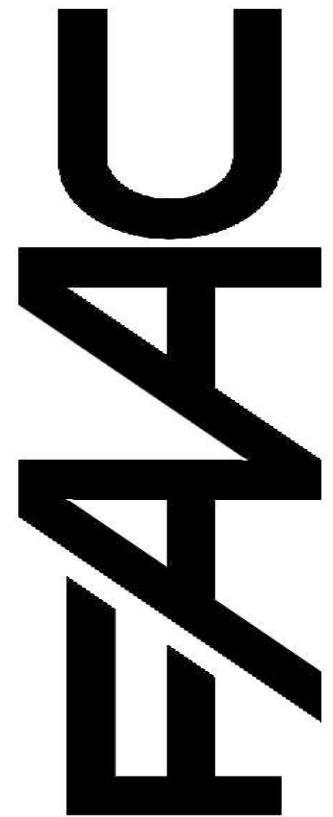

FAAC International, Inc.
303 Lexington Avenue
Cheyenne, WY 82007
www.faacusa.com

IMPORTANT SAFETY INFORMATION

Both the installer and the owner and/or operator of this system need to read and understand this installation manual and the safety instructions supplied with other components of the gate system. This information should be retained by the owner and/or operator of the gate.

WARNING! To reduce the risk of injury or death

1. **READ AND FOLLOW ALL INSTRUCTIONS.**
2. Never let children operate or play with gate controls. Keep the remote control away from children.
3. Always keep people and objects away from the gate. **NO ONE SHOULD CROSS THE PATH OF THE MOVING GATE.**
4. Test the gate operator monthly. The gate **MUST** reverse on contact with a rigid object or stop when an object activates the non-contact sensors. After adjusting the force or the limit of travel, retest the gate operator. Failure to adjust and retest the gate operator properly can increase the risk of injury or death.
5. Use the emergency release only when the gate is not moving.
6. **KEEP GATES PROPERLY MAINTAINED.** Read the owner's manual. Have a qualified service person make repairs to gate hardware.
7. The entrance is for vehicles only. Pedestrians must use separate entrance.
8. **SAVE THESE INSTRUCTIONS.**

When installing the photo-beams supplied with this unit two things need to be considered.

1. Care should be exercised to reduce the risk of nuisance tripping, such as when a vehicle, trips the sensor while the gate is in motion.
2. One or more photobeams shall be located where the risk of entrapment exists, such as the perimeter reachable by the moving gate leaf.

GATE DESIGN

1. A gate is a potential traffic hazard, so it is important that you locate the gate far enough away from the road to eliminate the potential of traffic getting backed up. This distance is affected by the

size of the gate, how often it is used, and how fast the gate operates.

2. The operator you choose to install on your gate must be designed for the type and size of your gate and for the frequency with which you use the operator.
3. Your gate must be properly installed and must work freely in both directions before the automatic operator is installed.
4. An automatic operator should be installed on the inside of the property/fence line. Do not install the operator on the public side of the property/fence line.
5. Pedestrians should not use a vehicular gate system. Prevent such inappropriate use by installing separate gates for pedestrians.
6. Exposed, reachable pinch points on a gate are potentially hazardous and must be eliminated or guarded.
7. Outward swinging gates with automatic operators should not open into a public area.
8. The operating controls for an automatic gate must be secured to prevent the unauthorized use of those controls.
9. The controls for an automatic gate should be located far enough from the gate so that a user cannot accidentally touch the gate when operating the controls.
10. An automatic gate operator should not be installed on a gate if people can reach or extend their arms or legs through the gate. Such gates should be guarded or screened to prevent such access.

INSTALLATION

1. If you have any question about the safety of the gate operating system, do not install this operator. Consult the operator manufacturer.
2. The condition of the gate structure itself directly affects the reliability and safety of the gate operator.
3. Only qualified personnel should install this equipment. Failure to meet this requirement could cause severe injury and/or death, for which the manufacturer cannot be held responsible.
4. The installer must provide a main power switch that meets all applicable safety regulations.
5. Clearly indicate on the gate with the 2 warning signs that are included (visible from either side of the gate).

6. It is extremely unsafe to compensate for a damaged gate by increasing hydraulic pressure.
7. Devices such as reversing edges and photobeams must be installed to provide better protection for personal property and pedestrians. Install reversing devices that are appropriate to the gate design and gate application.
8. Before applying electrical power, be sure that the voltage requirements of the equipment correspond to your supply voltage. Refer to the label on your operator system.

USE

1. Use this equipment only in the capacity for which it was designed. Any use other than that stated should be considered improper and therefore dangerous.
2. When using any electrical equipment, observe some fundamental rules:
 - Do not touch the equipment with damp or humid hands or feet.

- Do not install or operate the equipment with bare feet.
 - Do not allow small children or incapable persons to use the equipment.
3. If a gate system component malfunctions, turn off the main power before making any attempt to repair it.
 4. Do not attempt to impede the movement of the gate. You may injure yourself as a result.
 5. This equipment may reach high temperatures during operation; therefore, use caution when touching the external housing of the operator.
 6. Learn to use the manual release mechanism according to the procedures found in this installation manual.
 7. Before carrying out any cleaning or maintenance operations, disconnect the equipment from the electrical supply.
 8. To guarantee the efficiency of this equipment, the manufacturer recommends that qualified personnel periodically check and maintain the equipment.

U.L. CLASS AND FAAC OPERATOR

Model	Duty Cycle	Typical Use
Class I: Residential Vehicular Gate Operator		
402	750	<ul style="list-style-type: none"> • Home use • Small apartment building, for example, up to 4 units in a building, with limited public access
422	760	
412	400	
620	640	
885		
	Limited duty	
Class II: Commercial/General Access Vehicular Gate Operator		
400	640	<ul style="list-style-type: none"> • Apartment buildings • Very public access
620	885	
	Continuous duty	
Class III: Industrial/Limited Access Vehicular Gate Operator		
400	640	<ul style="list-style-type: none"> • No public access
620	885	
	Continuous duty	
Class IV: Restricted Access Vehicular Gate Operator		
620	640	<ul style="list-style-type: none"> • Prison rated security
885		
	Continuous duty	

TECHNICAL DATA

THE 422 COMPACT OPERATOR

Parameter	422 Standard	422 VHS
Physical dimensions:		
Weight, lb (kg)	15-1/2 lb (7.0 kg)	14-1/3 lb (6.5 kg)
Length, in. (mm)	38 7/8 in. (987 mm)	32-9/16 in (827 mm)
Width ´ height, in. (mm)	3-1/2 x 4-1/2 (90 x 114mm)	3-1/2 x 4-1/2 (90x 114 mm)
Motor speed, rpm	1400	
90-deg opening time, sec	12	6
Thrust and traction force, lb (kg)	0-1100 (0-500)	
Hydraulic Locking	In both opened and closed positions	
Cycles per hour	30	
Power voltage required, VAC (frequency, Hz) ¹	115 (50-60) ± 10% or 230, +6 or -10% (50-60) ¹	
Current draw, amps	115v = 1.5 Amps, 230v = 1.0 Amps	
Operating temperature range, deg F (deg C)	-33 to 165 (-36 to 75)	
Thermal cut out, deg F (deg C)	212 (100)	
Oil quantity, qt (liter)	1 (0.9)	7/8 (0.8)
Oil type	Lubrication Engineers — MONOLEC 6105	
Gate leaf constraints		
Maximum weight per leaf, lb (kg)	900 (410)	440 (200)
Maximum length per leaf, ft (m)	10 (3)	4 (1.2)
Maximum gate leaf swing, deg	90	

Your standard 220 VAC power source meets the specification for the required power supply of 230 VAC, +6 or -10%.

UNPACKING THE OPERATOR

When you receive your 422 Compact Operator, complete the following steps.

Inspect the shipping box for physical damage such as leaking oil or a torn carton. Then inspect the operator after you remove it from the box. Notify the carrier immediately if you note any damage because the carrier must witness the damage before you can file a claim.

As you unpack the box, insure that all the following parts included (see Figure 1). If you have ordered a kit (a pair of operators), you will have twice the quantity of parts listed below (except where noted), and you will also have a radio receiver and two transmitters.

- 1 422 Operator - 1 each
- 2 Protective Cover - 1 each
- 3 Protective Cover Screw - 1 each
- 4 Protective Cover End Cap - 1 each
- 5 Rear Mounting Bracket - 1 each
- 6 Rear Mounting Plate (optional) - 1 each
- 7 Short Brass Pin with 8mm nut and washer - 1 each
- 8 Rear Fork - 1 each
- 9 Long Brass Pin with 8mm self-locking nut - 1 each
- 10 Swivel joint with jam nut and washer - 1 each
- 11 Front mounting bracket with nut and bolt
- 12 Locking cap cover and key for Manual Release - 1 each

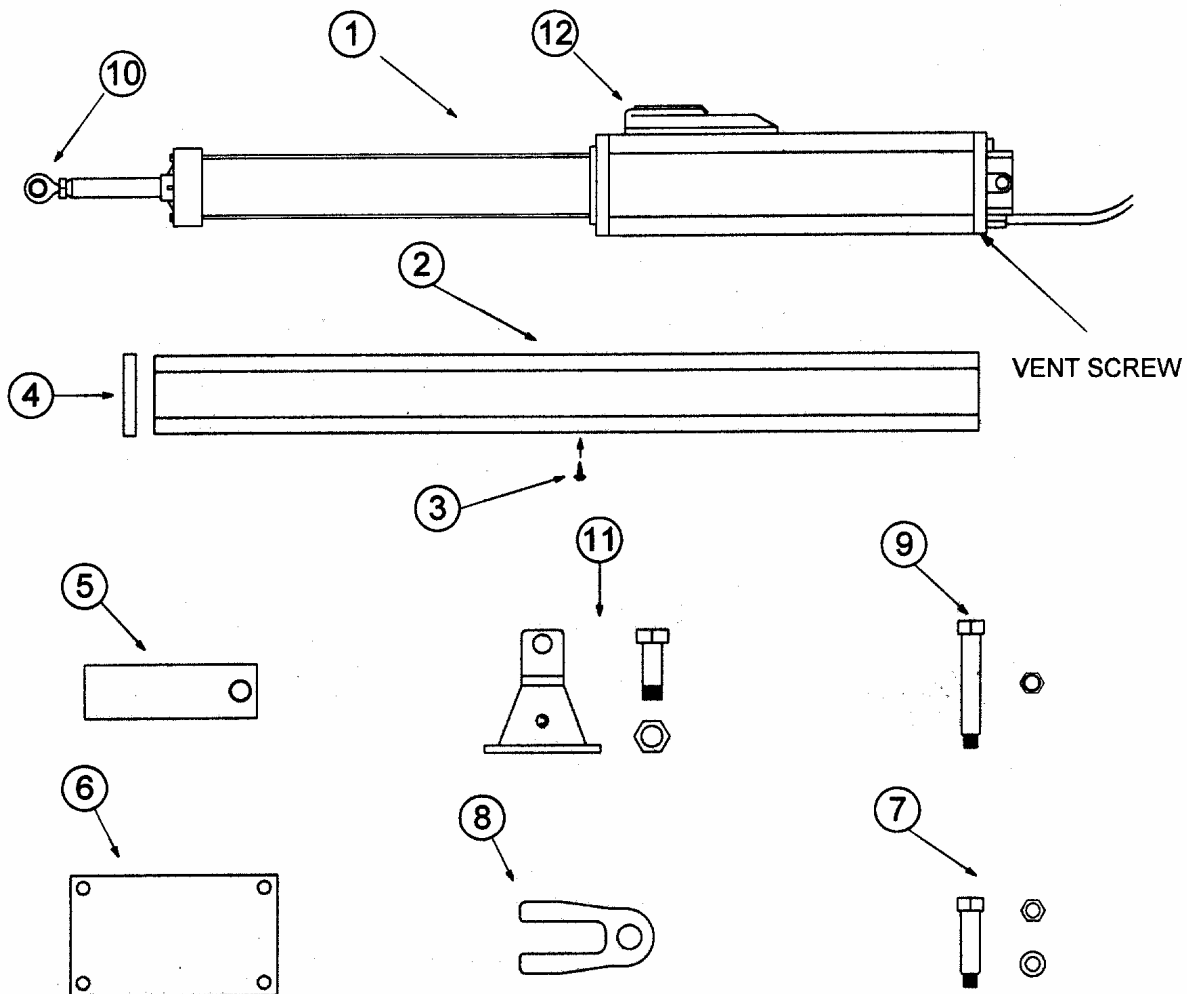

Figure 1. The 422 Compact Operator

THE 422 COMPACT OPERATOR

GENERAL CHARACTERISTICS

The FAAC 422 Operator is an automatic gate operator for a swinging gate leaf. It can accommodate a gate leaf of up to 900 lb (410 kg) and up to 10 ft (3 m) in length.

The self-contained 422 Operator is an electro-hydraulic unit consisting of an electric motor, a pump, a valve assembly, and a hydraulic cylinder, all housed in an anodized aluminum oil reservoir.

The 422 Operator can be used to swing the gate leaf inward or outward. Most versions provide hydraulic locking in at least one position, either opened or closed, depending on how it was ordered.

The hydraulic lock is a service device rather than a security device. Additional, external locks are recommended under the following conditions:

- You are installing the Model 422 SB
- The length of the gate leaf is 12 ft or more
- The installation requires tight security
- The site is subject to vandalism
- The site is subject to strong or very gusty wind
- You are installing a solid face gate

For gates with two leaves, two operators are installed, one on each leaf, and both are wired to one control panel. In such two-operator gate installations, one leaf can be programmed to open/ close slightly later than the other leaf to accommodate overlapping gate designs.

For its protection, the single-phase, bidirectional motor shuts off automatically if its operating temperature reaches 212 deg F (100 deg C). Also for the protection and proper operation of the 422 Operator, each gate leaf on which it is installed must have a fixed positive stop in both the opened and closed positions.

The 422 Operator also includes a key-operated Manual Release mechanism and two bypass valves that precisely control the force applied to the gate leaf through the 422 Operator.

The Manual Release mechanism is a key-operated device that disengages (or engages) the hydraulic system of the 422 Operator. When the hydraulic system is disengaged, you can open and close the gate leaf by hand. Such manual operation of the gate is necessary during installation and useful during power failures. The two bypass valves are located beneath the locking cap. You need to adjust the bypass valves to meet the safety standards of FAAC International, Inc. The standards state that the gate leaf should stop if it encounters a force of more than 33 lb (15 kg).

Additional reversing devices (such as inductive loops and photocells) should be installed to provide more complete protection for people and property.

The electronic control panel is a microprocessor-based controller that accepts a wide range of product accessories and reversing devices, thus allowing for flexible gate system design.

INSTALLATION INSTRUCTIONS

Installing the 422 Compact Operator involves preparing the gate, installing the operator(s), installing the control panel, and fine-tuning the pressure adjustments on the operator(s).

Note: The following installation instructions assume you are fully capable of installing an operator. This manual does not instruct you in designing a gate, installing a gate, or basic electrical wiring. The installation tasks discussed in this manual are tasks particular to the 422 Operator.

PREPARING THE GATE

Before installing the 422 Operator, you need to prepare the gate itself for the operator. Be sure to do the following things:

1. Make sure that the gate is plumb.
2. Make sure that the gate moves smoothly on its hinges without excessive friction by swinging it open and closed by hand. Lubricate all the gates' moving parts.
3. Provide positive stops for the gate leaves in the fully open and fully closed positions (see Figure 2).

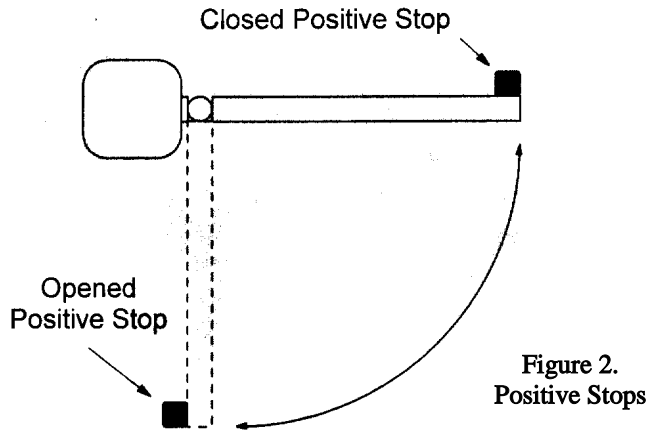

Figure 2.
Positive Stops

MANUAL RELEASE MECHANISM

For installation of the locking cap cover see page 10. To access the keyhole, slide the key-hole cover in the direction of the arrow (see Figure 3). Insert the key and turn it counterclockwise one full turn to disengage the operator's hydraulic system. You can now move the gate leaf slowly by hand to open or close the gate.

Operating the gate leaf by hand is necessary during installation and is useful during power failures.

You re-engage the hydraulic system by turning the key clockwise one full turn. Remove the key and slide the cover closed.

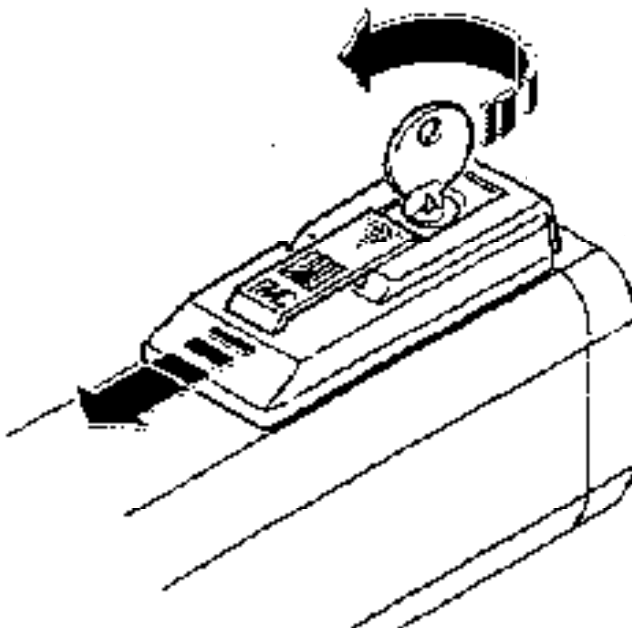

Figure 3. After sliding the cover open on the Model 422, insert and turn the key counterclockwise one full turn to release the hydraulic system

INSTALLING THE OPERATOR

Installing the 422 compact operator consists of the following steps:

1. Attach the rear mounting bracket
2. Attach the mounting hardware
3. Attach the front mounting bracket
4. Attach the operator to the gate
5. Adjust the operator pressure

ATTACH THE REAR MOUNTING BRACKET

Attach the rear mounting bracket according to the dimensions in Figure 4.

WARNING! You must achieve the A and B dimensions, as specified in Figure 4. Modification of the rear bracket may be necessary to achieve these dimensions (i.e., cutting or extending the bracket provided)

If you have a steel gate post, weld the rear bracket directly to it. If the gate post is made of any other material, attach the optional mounting plate, with lag bolts or anchors, and weld the bracket to it.

For an outward swing gate refer to Figure 5.

ATTACH THE MOUNTING HARDWARE

Insert the rear fork (hex cut up if you have a nylon rear fork) into the rear flange of the operator. Secure with long brass pin and self-locking nut.

Screw the jam nut onto the swivel joint. Slide the washer on next and screw the swivel joint halfway into the piston rod. Temporarily attach the front mounting bracket to the swivel joint with the nut and bolt provided.

ATTACH THE FRONT MOUNTING BRACKET TO THE OPERATOR

Release the operator as shown in Figure 3. Put the operator into position and attach the rear fork to the rear mounting bracket using the short brass pin, washer, and nut.

For inward swing, pull the piston out completely and push back approximately $\frac{1}{4}$ " (6mm). For outward swing, push the piston in completely and pull back out approximately $\frac{1}{4}$ " (6mm).

Note: Be sure that the operator is level and that the gate is against the close positive stop.

Hold the front mounting bracket flush against the gate. Mark the location of the front mounting bracket. Remove the operator from the gate. Remove the front mounting bracket from the swivel joint.

Note: Clamping the front mounting bracket at the marked location before checking the swing, as instructed below, will ensure proper location of the front mounting bracket.

Bolt or weld the front mounting bracket to the marked location on the gate.

WARNING! Do not weld the front mounting bracket with the operator attached. Doing so will seriously damage the operator.

ATTACH THE OPERATOR TO THE GATE

Re-attach the operator to the mounting brackets. Once the operator is mounted and level, remove the vent screw from the bottom of the rear flange. (See Figure 1) Use the 3mm hex key on the end of the screwdriver provided.

WARNING! Failure to remove the vent screw may result in erratic operation of the operator or blown seals.

Slowly move the gate open and close.

WARNING! The piston should not bottom out in either direction. Doing so will seriously damage the operator.

Be sure that the gate reaches the positive stop before the piston bottoms out. Adjust the swivel joint if necessary.

After checking the swing of the gate, secure all nuts and bolts, including the jam nut on the swivel joint.

Once the operator is secure, install the protective cover over the piston of the operator, first insert the two spacers (items labeled 2 in Figure 6) in the front flange of the operator as shown. The spacers dampen any vibrations to the operator.

Once the protective cover is installed, swing the gate to ensure that it does not contact the cover at any point of the swing.

Re-engage the operator by inserting the key in the locking cap (see Figure 3) and turning it clockwise until snug. Remove the key.

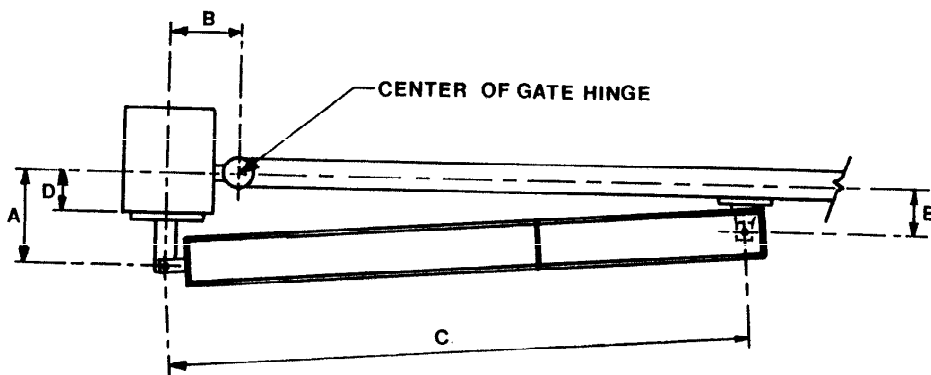

Figure 4. An inward swinging gate, top view: important mounting dimensions

	422 Standard	422 VHS
A	4-3/4 in. (114 mm)	3-1/8 in. (8 cm)
B	4-3/4 in. (114 mm)	3-1/8 in. (8 cm)
C	36-5/8 in. (93 cm)	29-3/4 in. (75.5 cm)
D	Max 2-3/4 in. (7 cm)	Max 1-1/8 in. (2.9 cm)
E	Must be less than A	Must be less than A

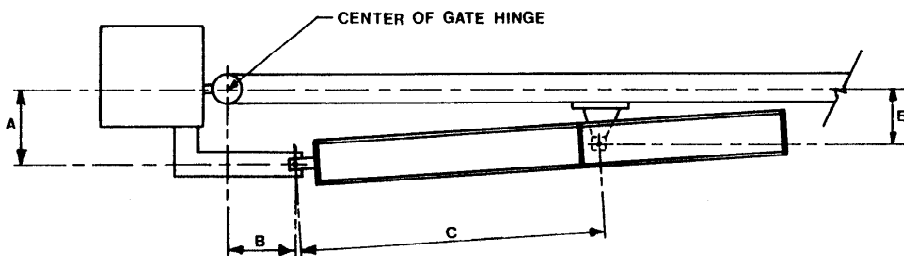

Figure 5. An outward swinging gate, top view: important mounting dimensions

	422 Standard	422 VHS
A	4-3/4 in. (12 cm)	3-1/8 in. (8 cm)
B	4-3/4 in. (12 mm)	3-1/8 in. (8 cm)
C	27 in. (673 mm)	23-1/4 in. (59 cm)
E	Must be less than A	Must be less than A

INSTALLING THE 455 D CONTROL PANEL

Locate the control panel in the most convenient position possible, considering the movement of the gate. Figure 9 on page 11 shows a basic layout for a two-leaf gate with the 422 Compact Operator.

Installing the control panel consists of the following general steps:

- Connecting the main power to the control panel
- Connecting the activating device
- Connecting the operator to the control panel
- Checking the direction of the motor's rotation
- Connecting other devices to the control panel
- Set operating modes

The installer is responsible for grounding the gate and operator systems, for providing the main power breaker switch, and for making sure that the entire gate system meets all applicable electrical codes.

For the complete 455 D Control Panel Installation Instructions, see pages 14—25 of this manual.

Before reinstalling the locking cap, you must be sure that the top of the brass key assembly in the locking cap is flush with the top of the black plastic locking cap (see Figure 7). If the key assembly is not flush, turn the locking cap assembly over and press down on the unit until the brass key assembly snaps back into place.

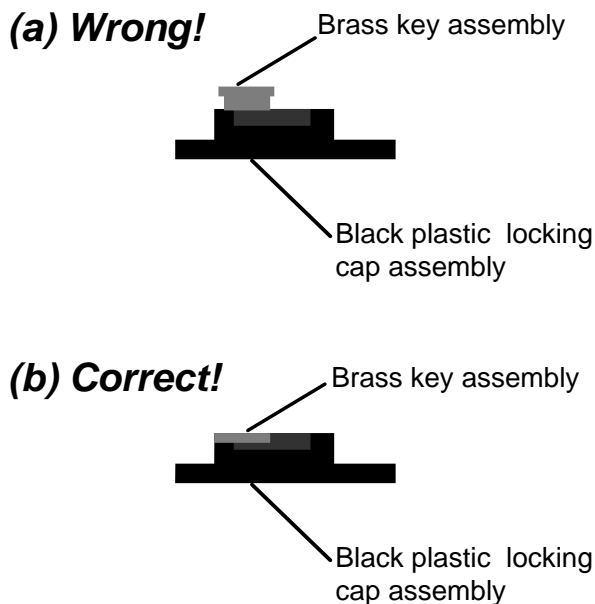

Figure 7. The brass key assembly in relation to the black plastic locking cap, side view: (a) do not install in this orientation and (b) install the locking cap only when the top of the brass key assembly is flush with the black plastic housing of the locking cap assembly.

WARNING! If the brass key assembly is not properly seated in the locking cap assembly, you risk damaging, even eliminating, the Manual Release function of the operator.

Next, reinstall the locking cap (without the key) with your 3 mm hex key and the two screws.

Now you can install the locking cap cover as shown in Figure 8. Snap the cover on before you attempt to slide the entire cover in the direction of the arrow. If the cover does not snap into place, you are unable to slide the cover into position.

BLEED THE OPERATOR

Air bubbles in hydraulic fluid cause erratic performance in a hydraulic system, so you must rid the 422 Operator of that air to insure smooth operation.

If you have removed the vent screw, the 422 operator should bleed itself. Running the operator should remove any air from the system. If the operator runs smooth throughout the swing, no attempt to further bleed the unit is necessary.

If the operator runs erratic, perform 10 bleeding operations. One bleeding operation consists of automatically opening and closing the gate and then pausing for two minutes. The 2-min pause allows the air bubbles to escape through the vent screw hole.

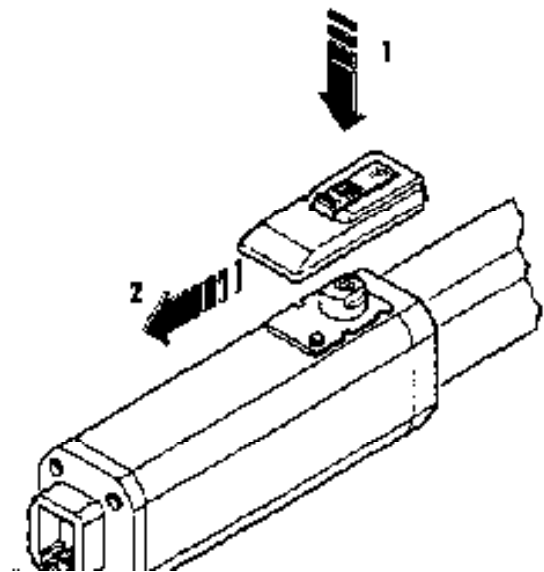
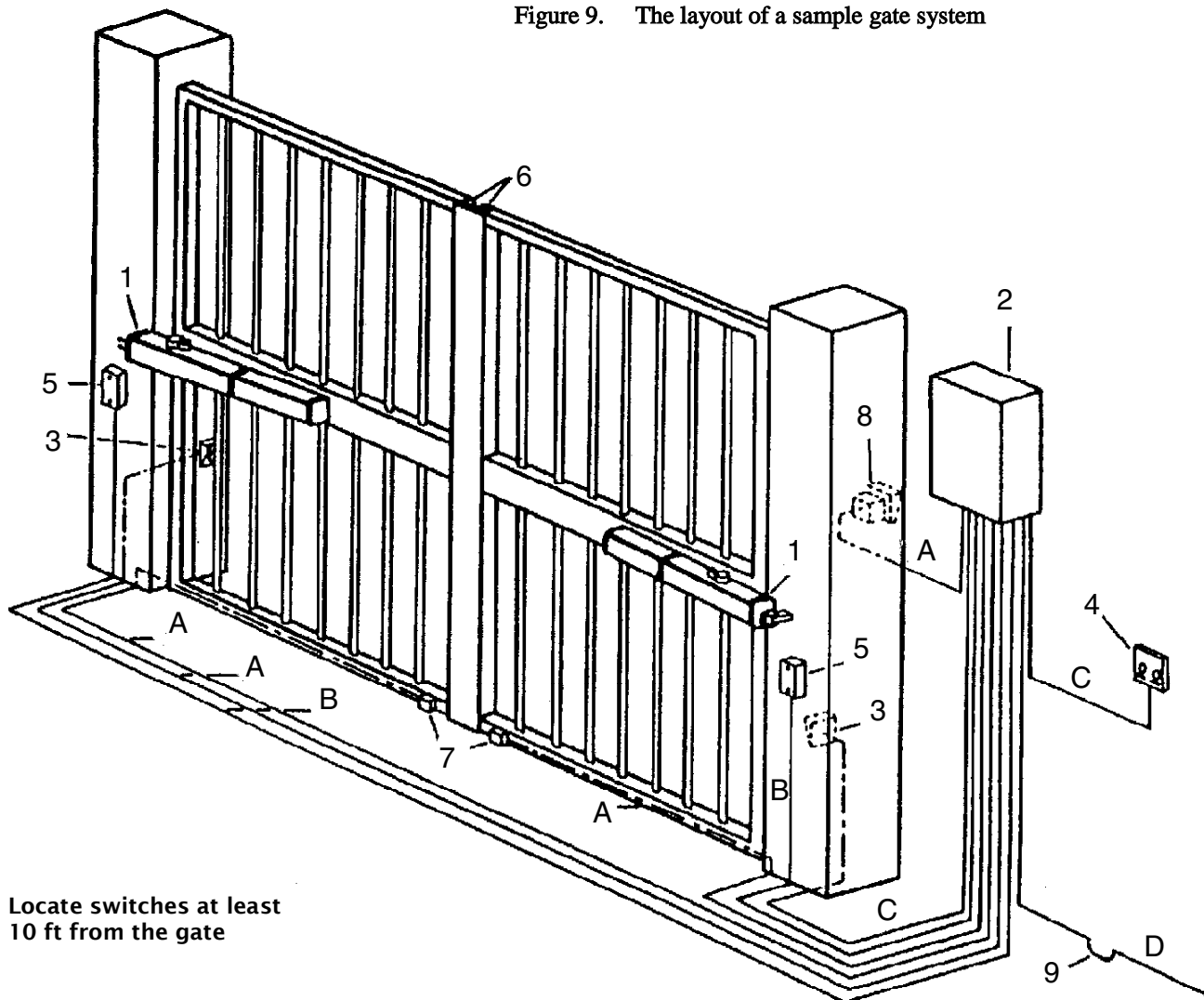

Figure 8. Install the locking cap cover

Figure 9. The layout of a sample gate system



Locate switches at least
 10 ft from the gate

- 1 Operator
- 2 Control Panel
- 3 Photocell
- 4 Switch
- 5 Junction box (see text)
- 6 Reversing edges
- 7 Gate stops
- 8 Switch
- 9 Wiring to main circuit breaker

Wire Gauges for Given Voltage

	220 VAC	115 VAC
A	2 × 18 AWG	A 2 × 18 AWG
B	4 × 14 AWG	B 4 × 14 AWG
C	5 × 18 AWG	C 5 × 18 AWG
D	4 × 14 AWG up to 414 ft	D 3 × 14 AWG up to 130 ft 3 × 10 AWG up to 340 ft

EXPLODED VIEW, 422 CBC

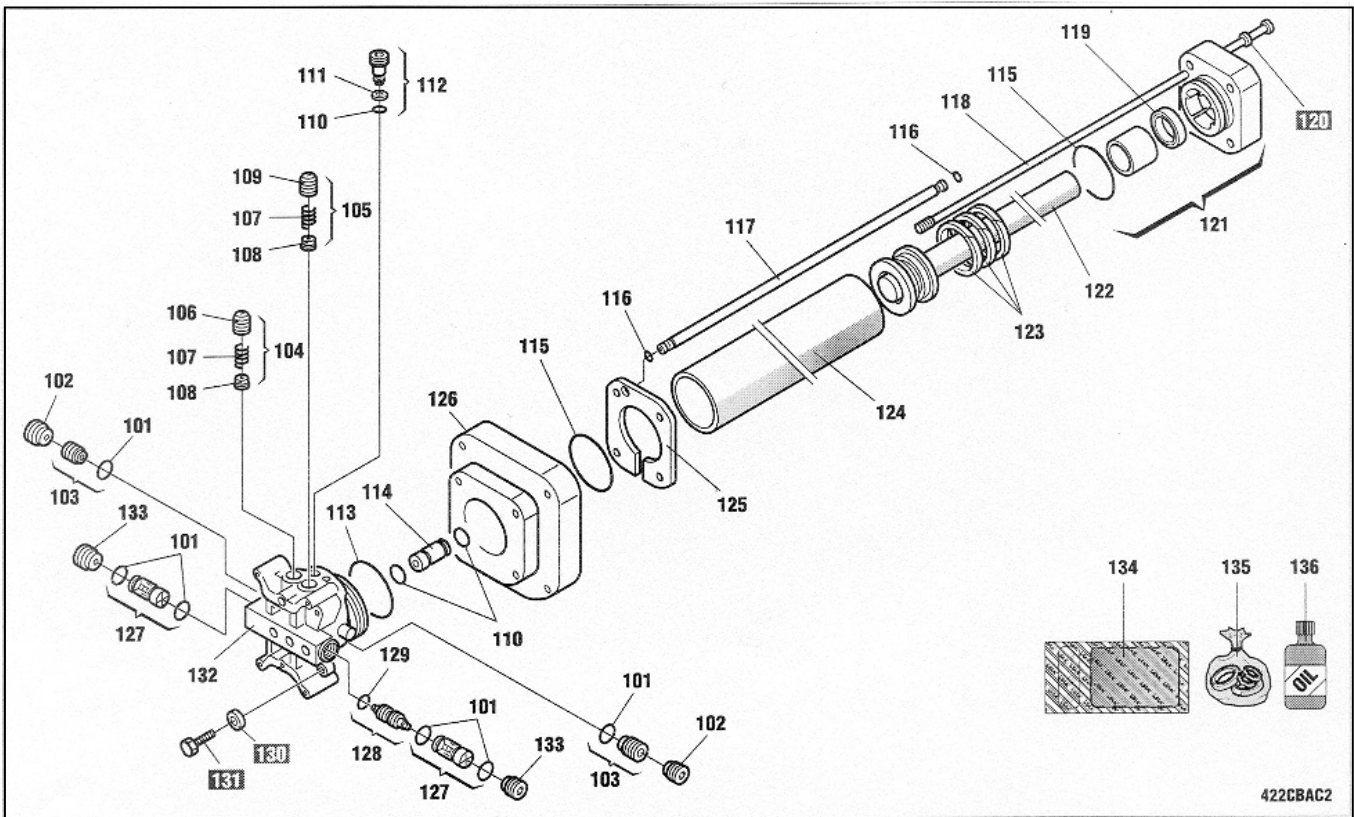
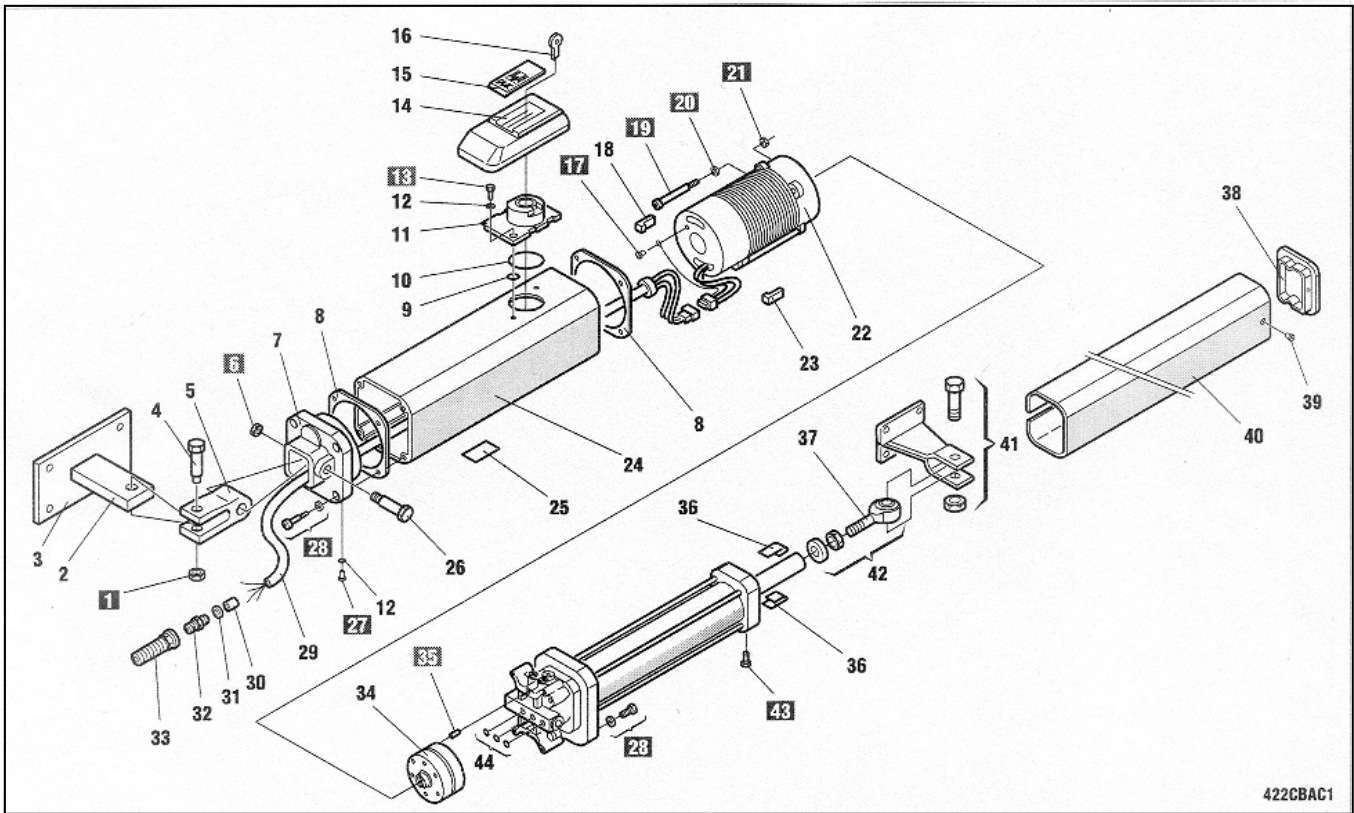

422 PARTS LIST

POS	PART NO.	DESCRIPTION	QTY
1	2036	Galvanized Nut (8mm)	1
2	7220015	Rear Bracket	1
3	7284005	Rear Bracket Plate	1
4	7182075	Short Pin	1
5	7221115	Rear Fork	1
6	2037	Self-Locking Nut (8mm)	1
7	7170595	Rear Flange	1
8	7099101	Gasket (D80)	2
9	7090440	O-Ring Locking Cap (Small)	2
10	7090655	O-Ring Locking Cap (Center)	1
11	41850215	Locking Cap	1
12	7094065	Gasket (copper)	3
13	2274	Vent Screw (4x6mm)	3
14	7270805	Locking Cap Cover	1
15	7270815	Access Slide (Locking Cap)	1
16	7131005	Viro Key (Manual Release)	1
17	N/A	Self Threading Screw	1
18	7119475	Vibration Dampener	2
19	2365	Motor Bolt (4X50mm)	4
20	2366	Lock Washer	4
21	2367	Hex Nut (4mm)	4
22**	77000425	115V 1400 RPM Motor	1
23	7119485	Vibration Dampener	2
24	309005	Operator Body	1
25	N/A	Vent Screw Label	1
26	7182175	Long Pin	1
27	2274	Vent Screw	3
28	N/A	Torx (Self Threading) T20	8
29	7514055	Electric Power Cord	1
30*	2581	Fiber Washer	1
31*	7039305	Strain Relief Brass Washer	1
32*	7109155	Strain Relief Nut	1
33*	7109145	Strain Relief	1
34	3204395	1Lt Lobe Pump	1
35	N/A	Pump Pin	2
36	760285	Spacers (Protective Cover)	2
37	4900605	Swivel Joint	1
38	7271545	Protective Cover End Cap	1
39	7114025	Protective Cover Plug	1
40	7272125	Protective Cover	1
41	7220515	Front Mounting Bracket	1
42	4900605	Swivel Joint Kit	1

POS	PART NO.	DESCRIPTION	QTY
43	N/A	Self Threading Screw	1
44	7090010015	O-Ring	3
101	7090050015	O-Ring	6
102	7049135	Valve Retainer	2
103	4404065	Inlet Valve	2
104	4180035	Red By-Pass Cap Assembly	1
105	4180045	Green By-Pass Cap Assembly	1
106	7119015	By-Pass Cap (Red)	1
107	7210025	By-Pass Spring	2
108	7310315	By-Pass Cap	2
109	7119115	By-Pass Cap (Green)	1
110	7090280015	O-Ring Retract Tube (Short)	3
111	7043055	Extrusion Ring	1
112	4180195	Manual Release	1
113	7090360	O-Ring (Valve Body)	1
114	7361035	Retract Tube (Short)	1
115	7090350	O-Ring (Mid Flange)	2
116	7090665	O-Ring Retract Tube (Long)	2
117	7361315	Retract Tube (Long)	1
118	7230225	Tie-Rod (Cylinder)	4
119	N/A	O-Ring Front Flange (Internal)	1
120	N/A	Star Washer	4
121	4994165	Front Flange	1
122	4350085	Piston Assembly	1
123	7095035	Piston Rod Packing	1
124	7366065	Cylinder	1
125	7271555	Protective Cover Guide	1
126	499449	Mid Flange	1
127	4404085	Lock Valve	2
128	4180285	Shuttle Piston	1
129	7090300	O-Ring (Shuttle Piston)	1
130	N/A	Galvanized Washer	4
131	N/A	Galvanized Screw	4
132	4994345	Valve Body (CBAC)	1
133	7049005	Valve Retainer (Brass)	2
134	3905255	Skin Pack	1
135	2172*	Seal Kit	1
136	6105	1 Qt Monolec Oil	1

* Included in Kit #2167A*

* * 220V 1400RPM Motor Part #77000415

THE 455 D CONTROL PANEL

GENERAL DESCRIPTION

The FAAC 455 D control panel is used to operate the following models.

Swing gate operators:

400	412
402	750
422	760

Barrier gate operators:

610/615

The 455 D programming controls the following:

Operating logic: A, S, E, EP, B, and C logics available.

Reversing device behavior: Choose whether a triggered reversing device during closing immediately reverses gate movement or stops the gate and reverses gate movement when no longer triggered.

Torque or Pressure: Force adjustment for the 412 operator. Adjustable from 0 to 50.

Caution: For all hydraulic operators, the torque **must** be programmed to the maximum (50) setting.

Pause time between opening and closing: adjustable from 0 to 240 seconds.

Opening/Closing time: adjustable from 0 to 120 seconds.

Leaf delay on closing: adjustable from 0 to 28 seconds.

The 455 D control panel should be installed in an enclosure that is conveniently located as close as possible to the gate operator. All electrical connections from the control panel to the operator must be made in a weatherproof junction box.

The 455 D control panel requires a single-phase power supply voltage (115 VAC [$\pm 10\%$] or 230 VAC [$+6$ or -10%], 50-60 Hz). The power supply should be protected by a 15 amp dedicated circuit breaker (not provided).

The installer is responsible for grounding the operator system, for providing the main power

breaker switch, and for making sure that the entire gate system meets all applicable electrical codes. The installer should refer to the installation manual for a given operator for more information.

NOTE: An installation is U.L. compliant only when you install the FAAC operators according to the UL325 standards.

INSTALLING THE 455 D CONTROL PANEL

Locate the control panel in the most convenient position possible, considering the movement of the gate.

Installing the control panel consists of the following general steps:

- Connecting the main power to the control panel
- Connecting the activating device
- Connecting the operator to the control panel
- Checking the direction of the motor's rotation
- Connecting other devices to the control panel
- Set operating modes

CONNECT THE MAIN POWER SUPPLY

WARNING! Turn the main power off before you make any electrical connections or before programming.

Wire the main power supply to control panel terminals in block J3 (see Figures 11 and 12). The installer is responsible for insuring that a separate, grounded circuit protected by a circuit breaker is between the control panel and the main power supply. All wiring should conform to applicable electrical codes, and all wiring and fittings should be weatherproof and/or suitable for burial.

Connect the ground to the grounding terminal in block J3 and connect the power wires to the terminals labeled N (neutral) and L (line).

NOTE: For a 230V system, a neutral is not needed. Connect one 115V line to the L (Line) and a second 115V line to the N (Neutral).

CONNECT THE OPERATOR(S) TO THE CONTROL PANEL

WARNING! Turn the main power off before you make any electrical connections or before programming.

CAUTION: The operators are grounded only by the grounded circuit the installer provides.

USING A JUNCTION BOX

If an operator is more than 2 ft away from the control panel, you must use a junction box for connection. Use a U. L. Listed cord grip where the operator cord enters the junction box.

Note: If you have a one-leaf gate design, the operator **must** be connected to Motor 1 (terminals 1,2, & 3)

To wire up motor 1, connect the white wire to terminal 1(on the J4 terminal strip), the black wire to 2, and the red wire to 3. Wire each leg of the capacitor (supplied) to terminals 2 & 3.

Note: If you want to delay the closing of one gate leaf in a two-leaf gate design, be sure to connect its operator to Motor 1.

In order to wire motor 2 in a bi-parting system, connect the white wire to terminal 4 (on the J4 terminal strip), the black wire to 5, the red wire to 6. Wire each leg of the capacitor (supplied) to terminals 5 & 6.

CHECK THE MOTOR'S DIRECTION OF ROTATION

After you have connected the main power supply, and the operator(s) to the control panel, you need to check the direction of rotation for each operator motor in your gate design.

Note: To check a motor's direction of rotation, you must have three closed circuits on terminal block J1. Install one circuit between terminals 11 and 16, another circuit between terminals 12 and 19, and another circuit between terminals 13 and 19.

Figure 10. The 455 D Control Panel

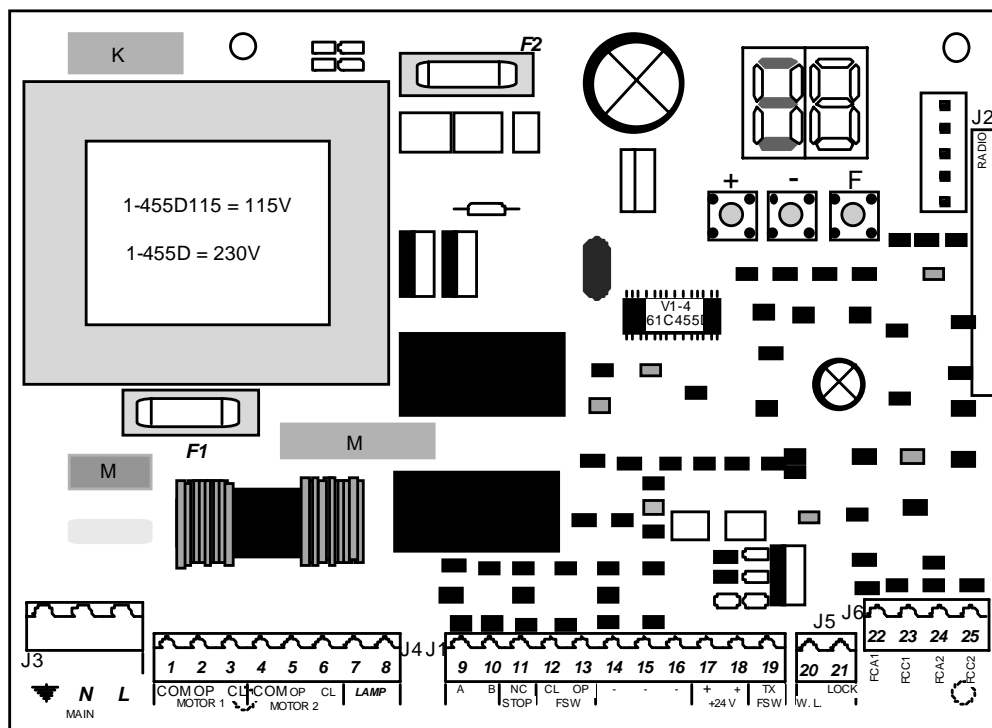

J3 terminal block for main power supply		
J4 terminal block for connecting the operator(s)		
J1 terminal block for low-voltage accessories		
J2 quick connector port		
F Function Push Button		
— Programming Push Button		
+ Programming Push Button		
FUSES	220 VAC	115 VAC
F1 Main Power	5 A	10 A
F2 Accessories	800 mA	800 mA

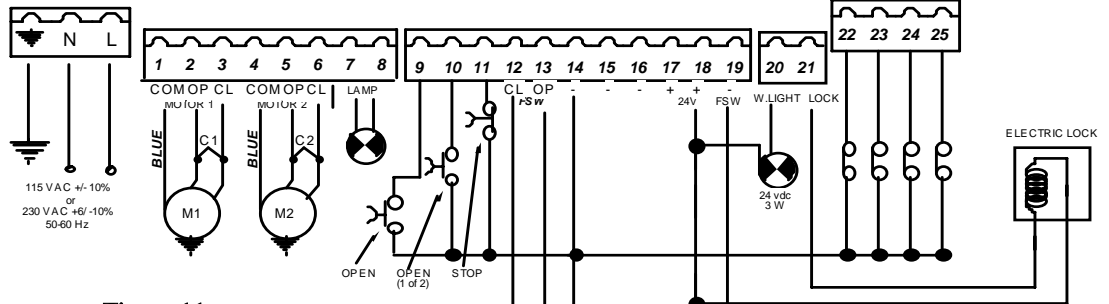

Figure 11.
The terminal strip wiring of the
455 D with photobeams

NOTE: In order to comply with UL 325, two sets of FAAC photobeams must be installed. One set should be 6 in. outside the closed gate(s) and act as a closing reversing device. Another set should be 6 in. beyond the swing of the gate(s) and act as an opening reversing device. The installer is responsible for determining the appropriate mounting height.

You cannot check the motor's direction of rotation without these circuits (jumpers) or the accessories. When properly prepared for testing, the LEDs FSWOP, STOP, and FSWCL should be illuminated (see figure 13 on page 17).

WARNING! Running the operator—even for testing purposes—without a connected reversing device is potentially dangerous. Do not place yourself within the path of the moving gate during your test.

Disengage the operator(s) with the Manual Release key (see operator installation manual), and open the gate by hand about halfway.

Next, engage the operator(s) with the Manual Release key so that you can check the rotation of the motor (s).

To activate the operator(s) momentarily short across terminals 9 and 14.

Turn on the main power and send an activating signal to the operator. The gate leaf (or leaves) should open. If a gate leaf closes, then you need to turn off the main power and reverse the connection of the red and black wires on terminal block J4 for the operator controlling that leaf. Then you need to recheck the rotation direction again.

After having completed your test of the motor's direction of rotation, replace any test circuits you installed (between terminals 11 and 16, between 12 and 19, and between 13 and 19) with the proper reversing and stop devices. The instructions for installing such accessories follow.

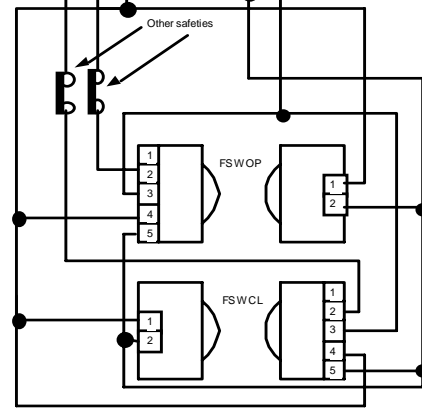

CONNECT OTHER DEVICES

WARNING! Turn the main power off before you make any electrical connections.

POWER SUPPLY FOR ACCESSORIES: You can access a 24 VDC output for supplying power to accessories through terminals 17 or 18, (+) and 14 or 15 or 16, (-) on terminal block J1. In most cases, this source can be used to power 24 VDC accessories.

NOTE: The 455 D control panel allows a maximum accessory load of 800 mA.

REVERSING DEVICES: Reversing devices include photocells, inductive loops, and so forth. All of the reversing devices should have contacts of the normally closed (N.C.) type. Where you connect a device depends on whether you want the device to operate during opening or during closing.

NOTE: UL **does not** recognize the FAAC system with loop detectors or safety edges. FAAC photobeams must be used to comply with UL 325.

To wire photobeams, refer to page 19 (see FSWOP for opening photobeams, and FSWCL for closing photobeams). Photobeams must be connected as shown. See also page 19 for the wiring of inductive loops. If using more than one reversing device, they must be wired in series.

(a) To the U. L. Listed gate operator

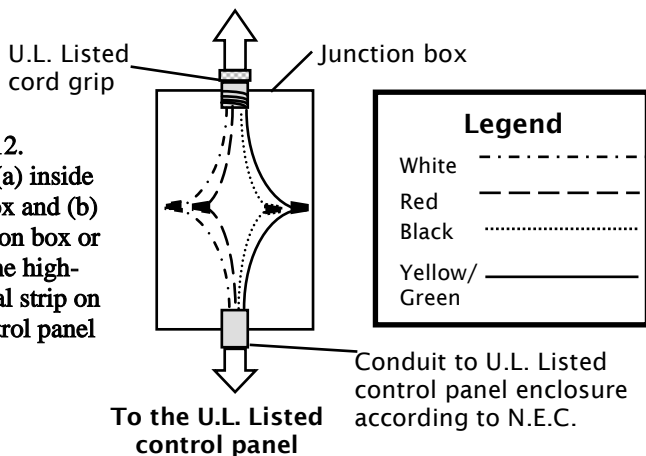
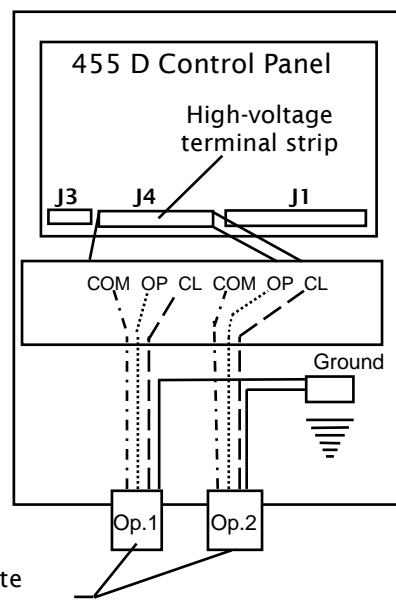

Figure 12.
 Wiring detail (a) inside the junction box and (b) from the junction box or operator to the high-voltage terminal strip on the 455 D control panel

(b) U.L. Listed Control Panel Enclosure



Cord grip or conduit from U.L. Listed gate operator(s)

ACTIVATING DEVICES AND RADIO RECEIVER: The activating devices and radio receiver for your gate must have normally open (N.O.) contacts. Connect such devices to terminals 9 and 14.

NOTE: The FAAC radio receiver plugs into the 5 prongs labeled J2 (Quick connect port).

Page 19 shows how to connect a three or four wire receiver.

DECODER CARD: If you are installing the Digicard magnetic card reader, or the Digikey keyboard, use the quick-fit connector J2 for the DS decoder card (see Figure 10).

NOTE: If your using both a receiver and decoder, hard wire the decoder and plug in the receiver.

OPEN/HOLD OPEN DEVICE: To open and hold open the gate, simply maintain a contact across terminals 9 and 14. ("A" Mode only)

STOP BUTTON: The stop button you install must have normally closed (N.C.) contacts. Multiple stop buttons must be wired in series. Connect your stop device between terminals 11 and 16.

NOTE: The 455 D will not operate the motors without a closed circuit between 11 & 16.

The LED Indicators: The nine light emitting diodes (LEDs) on the control panel can be used to check for the proper function of the devices attached to the panel. The LED lights are on whenever the contacts are closed across each of the respective terminals.

OP_A and OP_B (Partial Opening) should illuminate only when an activating signal is sent for 2 and 1 gate leaves, respectively. STOP should be illuminated except when the stop button is pressed. FSWOP and FSWCL should be illuminated except when the reversing devices, for

LED	On	Off
OP_A	Command Given	No Command
OP_B	Command Given	No Command
Stop	No Command	Command Given
FSW Open	Opening reversing devices clear	Reversing device triggered
FSW Close	Closing reversing devices clear	Reversing device triggered
FCA1 FCC1	Flashes when gate coder is in use. Operator 1	
FCA2 FCC2	Flashes when gate coder is in use. Operator 2	

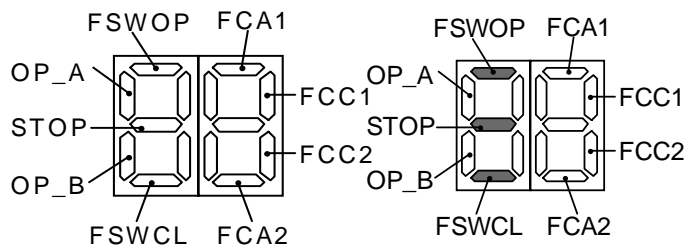

This display shows the meaning of each LED.

This display shows the normal status of the control panel.

Figure 13. The 455 D display.

opening and closing, respectively, are triggered. Use the LEDs and the next table to determine if the accessory devices you have installed are operating properly.

Electric Locks: An electric lock can be wired to the 455 D in terminals 18 and 21 (12Vac pulsed provided). If a reversing stroke is needed to allow the electric lock to release, this must be done in advanced programming.

See page 19 for the connections for a magnetic locking device.

WARNING LIGHT: Connect a warning light to terminals 18 and 20 in the group labeled *W.LIGHT* in terminal block J1 and J5. The terminals provide an output voltage of 24 VDC, maximum power 3 Watts. This output voltage will power most 24 VDC warning lights.

NOTE: The behavior of the warning light varies according to the logic you have set.

LOGICS A, S, E, EP, AND B: The warning light is on steadily during opening and the pause phase. During closing, the light flashes.

LOGIC C: The warning light is on steadily during opening and flashes during closing.

SET OTHER OPERATING CONTROLS

WARNING! Turn the main power off before you make any electrical connections.

You need to program the control panel for your gate's operation. The 455 D Control Panel has on board programming that controls a wide range of functions.

OPERATING LOGICS

NOTE: The 455 D Control Panel provides inputs for opening reversing devices and closing reversing devices. FAAC strongly recommends the use of reversing devices, such as photocells or other non-contact sensors.

- **A (automatic):** The gate opens on command and automatically closes after a pause phase. A second command while opening is ignored; a second command during the pause phase interrupts the pause time; a second command during closing reopens the gate. A maintained open command will hold the gate open.
- **S (security):** The security mode is like A logic except that a second command during opening immediately closes the gate. A maintained open command will not hold the gate open.

- **E (semi-automatic):** This mode requires a command to open and a command to close. A second command during opening stops the gate. A second command during closing reopens the gate.
- **EP (semi-automatic, step by step):** This mode requires a command to open and a command to close. A second command during opening or closing causes the gate to stop. A third command then reverses the previous motion of the gate.
- **B (manned, pulsed):** This mode is designed for guard station use and requires a three-button switch (pulsed) to open, close, and stop the gate.
- **C (manned and constant):** This mode requires constant pressure switches. One to open and one to close. No pressure on a switch stops the gate.

The three programming push buttons allow the programming of the torque (or pressure), the pause time between opening and closing, and the leaf delay on closing.

WARNING! Turn the main power off before you make any electrical connections.

For all FAAC hydraulic operators using the 455 D control panel, the force **must** be set at its maximum setting of 50 in order to supply the correct voltage to the operator.

PAUSE TIME: The pause time between opening and closing can be adjusted from 0 seconds to 4 minutes. Time is adjusted in one-second increments from 0—59 seconds. When 60 seconds is reached, time is adjusted in 10 second increments up to 4 minutes. i.e. if display shows 2.5, it means 2 minutes and 50 seconds.

LEAF DELAY: You may choose to delay one leaf on closing for overlapping gate leaves. Be sure the operator on the leaf for delayed closing is connected to Motor 1. On opening, the leaf connected to Motor 2 is delayed 2.5 sec.

NOTE: If an opening leaf delay is desired, it must be enabled in the Advance Programming. However, if enabled, you cannot *adjust* this opening delay of the operator connected to Motor 2.

The closing leaf-delay time is adjustable from 0 to 4 minutes.

NOTE: If the opening/closing time is set at less than the leaf delay time, the delayed leaf closes at the end of the closing time.

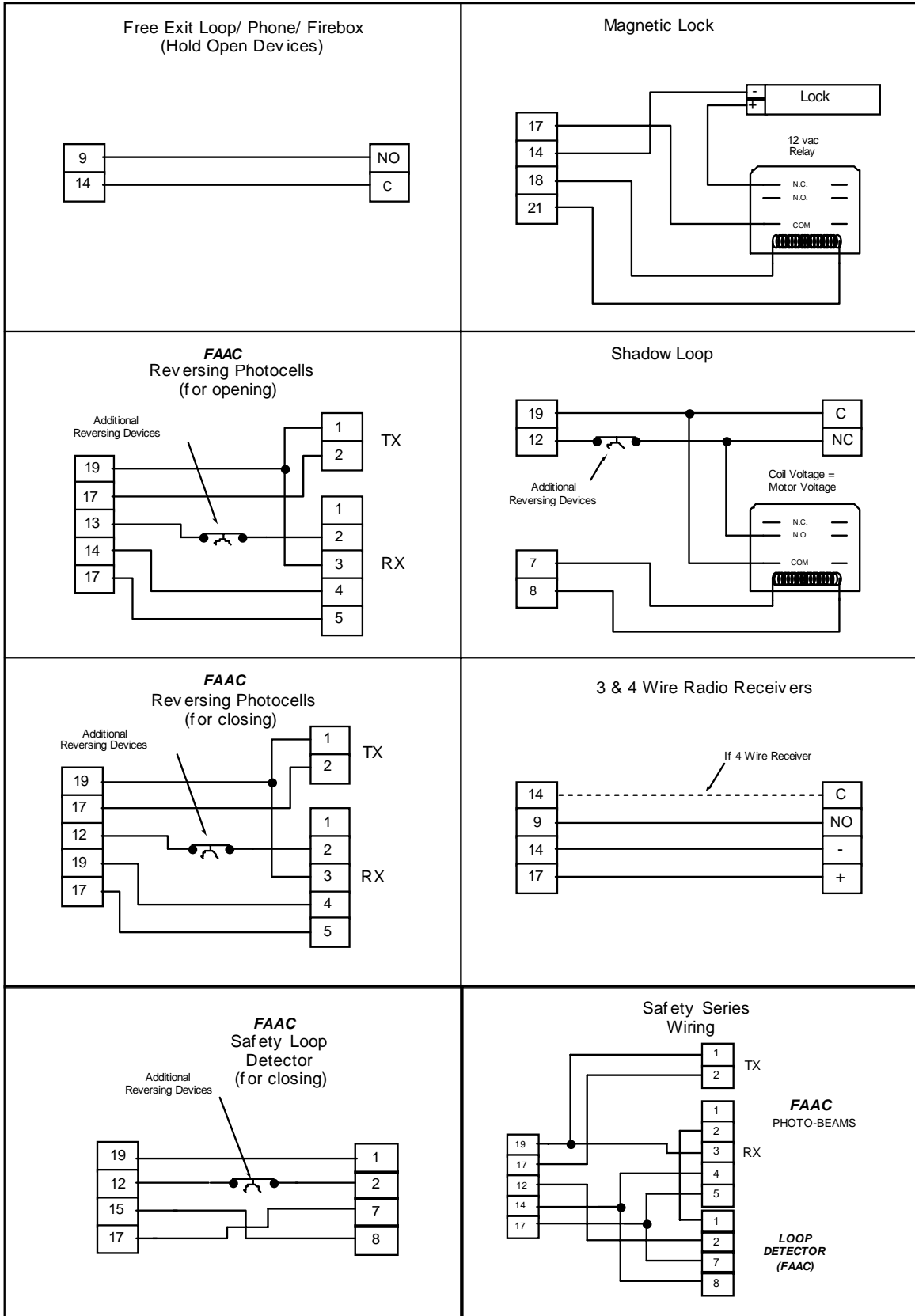

NO = Normally Open, NC = Normally Closed, C = Common, TX = Transmitter, RX = Receiver

Figure 14. Common Accessories wired to 455 D Control Panel

PROGRAMMING

To program the automated system, the "Programming Mode" must be accessed.

Programming is split into two parts: BASIC and ADVANCED.

BASIC PROGRAMMING

To access BASIC PROGRAMMING, press the "F" key.

- If you press it (and hold it down), the display shows the name of the first function.
- If you release the key, the display shows the value of the function that can be modified with keys + and - .
- If you press and hold down the "F" key again (and hold it down), the display shows the name of the next function, etc.
- When you reach the last function, press "F" to exit the program, and the display resumes showing the status of the inputs.

The table on the right shows the sequence of functions accessible in BASIC PROGRAMMING.

ADVANCED PROGRAMMING

To access ADVANCED PROGRAMMING, press the "F" key and, as you hold it down, press the "+" key:























- If you release the "+", the display indicates the name of the first function.
- If you release the "F" key, too, the display shows the value of the function that can be modified with keys "+" and "-".
- If you press the "F" key (and hold it down), the display shows the name of the next function, and if you release it, the value that can be modified with keys "+" and "-".
- When you reach the last function, press the "F" key to exit the program, and the display resumes showing the status of the inputs.

The table on page 9 shows the sequence of functions accessible in ADVANCED

PROGRAM BUTTONS		
+	-	F
LEFT	MIDDLE	RIGHT

BASIC PROGRAMMING		
Display	Function	Default
	OPERATING LOGICS A = Automatic (Timer to Close) E = Semi Automatic S = Security EP = (Semi-Automatic) Step by Step B = Manned, Pulsed C = Manned, constant	
	PAUSE TIME This is the time between open and closing and is adjustable from 0 to 4 min. This is only true in "A" Mode. (see pause time description)	
	FORCE/TORQUE MOTOR 1 This adjusts the force / torque that motor 1 is applying to the gate leaf. Setting is 0 to 50.*	
	FORCE/TORQUE MOTOR 2 This adjusts the force / torque that motor 2 is applying to the gate leaf. Setting is 0 to 50.*	
	CLOSING LEAF DELAY Delays the closing of operator wired into motor one outputs. Adjustable from 0 to 4 minutes (Same as pause time)	
	MOTOR RUN TIME This enables where you choose from "simple" learning or "complete" learning of the motor run time. See page 10 & 11 for complete details. Simple Learning ≈ 1 s. Complete Learning > 3 s.	
	EXIT PROGRAMMING Exit from programming and return to display of inputs status.	

* With Hydraulic operators the Force/Torque must be set to the maximum setting of 50.

ADVANCED PROGRAMMING			Display	Function	De- fault	
					INDICATOR-LIGHT: If 0 is selected, the output functions as a standard indicator-light (lighted at opening and pause, flashing at closing, and off when gate closed). Different figures correspond to timed activation of the output, which can be used (via a relay) to power a courtesy lamp. Time can be adjusted from 0 to 59s in 1s increments, and from 1.0 to 4.1 min. in 10s steps. 0 = Standard Indicator-Light From 1 to 4.1 = Timed Output	
Display	Function	De- fault				
	MAXIMUM TORQUE AT INITIAL THRUST: The motors operate at maximum torque (ignoring the torque setting) at start of movement. Useful for heavy leaves. 4 = Enable No = Disabled					
	LAST STROKE AT CLOSING: The motors are activated at full speed for 1s to facilitate locking of the electric lock. 4 = Enable No = Disabled					
	REVERSING STROKE: Before opening, while the gate is closed, the motors thrust to close for 2 s thus facilitating release of the electric lock. 4 = Enable No = Disabled					
	LEAF 2 OPENING DELAY (2s): Enables delayed start (at opening) of leaf 2, avoiding interference between leaves. 4 = Enable No = Disabled			A.D.M.A.P. FUNCTION: If this function is enabled, the safety devices operate in compliance with French standard NFP 25/362. 4 = Enable No = Disabled		
	FAIL SAFE: If this function is activated, it enables a function test of the photocells before any gate movement. If the test fails (photocells not serviceable), the gate does not start the movement. 4 = Enable No = Disabled			ASSISTANCE REQUEST (COMBINED WITH NEXT FUNCTION): If activated, at the end of countdown (settable with the next function, i.e. "Cycle programming") it effects 8s of pre-flashing at every Open pulse (job request). Can be useful for setting scheduled maintenance jobs. 4 = Enable No = Disabled		
	PRE FLASHING (5s): Activates the flashing lamp for 5s before start of movement. 4 = Enable No = Disabled			CYCLE PROGRAMMING: For setting count down of system operation cycles. Settable (in thousands) from 0 to 99 thousand cycles. The displayed value is updated as cycles proceed. This function can be used to check use of the board or to exploit the "Assistance Request" function.		
	ELECTRIC LOCK ON LEAF 2: For using the electric lock on leaf 2 instead of on leaf 1. 4 = Enable No = Disabled			EXIT PROGRAMMING: Exit from programming and return to display of inputs status.		

LEARNING OF OPERATING TIMES

WARNING: During the learning procedure, the safety devices are disabled! Therefore, any and all traffic must be avoided in the path of the gate leaf(s).

NOTE: Programming must start with the gate(s) in the closed position.

Opening/closing time is established by the learning procedure which varies slightly according to whether you are or are not using Gatecoders.

LEARNING OF NORMAL TIMES

Normal learning (i.e. without Gatecoders) can be done in two different ways:

SIMPLE LEARNING (WITHOUT SLOW DOWN)

Close the gates, enter "BASIC PROGRAMMING", select the TIME LEARNING function and press the + push-button for 1 second the display begins flashing and the leaves begin the opening movement.

Wait for the leaves to reach the opening positive stop and then supply an OPEN A command after the desired motor run time has been reached (by push-button or radio control) to stop the movement: the leaves stop and the display stops flashing. One more command given will close the gate.

The procedure has ended and the gate is ready to operate.

COMPLETE LEARNING (WITH SLOW DOWN)

NOTES:

- If you do not wish to slow the gate operator (s) down, wait for the gate to reach its positive stop and supply two (2) consecutive open commands (within 1 second).
- If only one gate operator (1) is used, you must go through the entire programming procedure, as if you were programming for two gate operators (2). When the operator has finished opening, supply 5 open commands until the gate operator begins to close, and then resume normal operations.

Close the gates, enter "BASIC PROGRAMMING", select the TIME LEARNING function and press the + push-button for more than 3 seconds: the display begins flashing and leaf 1 begins opening. The following functions can be commanded by the OPEN A (by push-button wired to terminals 9 and 14, or radio control):

- When gate operator (1) reaches the position that you want it to slow down, an open command must be given to start the slow down phase.
- When gate operator (1) reaches the positive stop and the desired motor run time has been reached, an open command must be given to shut the motor off. At this point gate operator (2) will automatically start to open.
- When gate operator (2) reaches the position that you want it to slow down, an open command must be given to start the slow down phase.
- When gate operator (2) reaches the positive stop and the desired motor run time has been reached, an open command must be given to shut the motor off. At this point gate operator (2) will automatically start to close.
- When gate operator (2) reaches the position that you want it to slow down, an open command must be given to start the slow down phase.
- When gate operator (2) reaches the positive stop and the desired motor run time has been reached, an open command must be given to shut the motor off. At this point gate operator (1) will automatically start to close.
- When gate operator (1) reaches the position that you want it to slow down, an open command must be given to start the slow down phase.
- When gate operator (1) reaches the positive stop and the desired motor run time has been reached, an open command must be given to shut the motor off.

The display stops flashing and the gate is ready for normal operation.

LEARNING TIMES WITH GATECODER

Learning with the Gatecoder can be done in two different ways:

SIMPLE LEARNING

Close the gates, enter "Basic Programming", select the TIME LEARNING function and press the + push-button for 1 second: the display begins flashing and the leaves begin the opening movement.

The movement stops automatically when the opening positive stop is reached and the display stops flashing.

The procedure has ended and the gate is ready to operate, using default slow down automatically set by the control panel.

COMPLETE LEARNING

NOTES:

- If only one gate operator (1) is used, you must go through the entire programming procedure, as if you were programming a gate operator (2). When the gate operator (1) has finished opening, supply 5 open commands until the gate operator begins to close, and then resume normal operations.

Close the gates, enter "BASIC PROGRAMMING", select the TIME LEARNING function and press the + push-button for more than 3 seconds: the display begins flashing and leaf 1 begins opening movement. The following functions can be commanded by the OPEN A command (by radio control or key push-button):

- When gate operator (1) reaches the position that you want it to slow down, an open command must be given to start the slow down phase. When the gate operator reaches its positive stop, the operator will automatically shut off.
- An open command must be given to start opening gate operator (2).
- When gate operator (2) reaches the position that you want it to slow down, an open command must be given to start the slow down phase. When the gate operator reaches its positive stop, the operator will automatically shut off.
- An open command must be given to start closing gate operator (2).

- When gate operator (2) reaches the position that you want it to slow down, an open command must be given to start the slow down phase. When the gate operator reaches its positive stop, the operator will automatically shut off.
- An open command must be given to start closing gate operator (1).
- When gate operator (1) reaches the position that you want it to slow down, an open command must be given to start the slow down phase. When the gate operator reaches its positive stop, the operator will automatically shut off.

The display stops flashing and the gate is ready for normal operation.

NOTES:

- The open command to slow down the gate should be given before the gate reaches the positive stop to prevent the gate from hitting the stop at full speed. The positive stop could be mistaken for an obstacle and then upon hitting it, the gate(s) would automatically reverse on contact.

AUTOMATED SYSTEM TEST

When you have finished programming, check if the system is operating correctly.

Most important of all, check that the force is adequately adjusted and that the safety devices are operating correctly.

If pressure adjustments on hydraulic operators are not set before programming. It may need to be reprogrammed for desired results.

A (Automatic) Logic (455 D)

Gate Status	Open A	Open B	Stop	Opening Reversing Device(s)	Closing Reversing Device(s)	Warning Light
Closed	Opens both leaves and closes them after pause time	Opens single leaf connected to Motor 1 and closes it after pause time	No effect	No effect	No effect	Off
Opening	No effect	No effect	Stops	Stops; gate closes when reversing device no longer triggered	No effect	On
Opened	Interrupts the pause time	Interrupts the pause time	Stops	No effect	Gate remains open until reversing devices no longer triggered	On
Closing	Opens both leaves	Opens leaf	Stops	No effect	Depends on DIP switch 4	Flashes
Stopped	Closes the leaves	Closes the leaf	No effect (opening is inhibited)	No effect	No effect (opening is inhibited)	On

S (Security) Logic (455 D)

Gate Status	Open A	Open B	Stop	Opening Reversing Device(s)	Closing Reversing Device(s)	Warning Light
Closed	Opens both leaves and closes them after pause time	Opens single leaf connected to Motor 1 and closes it after pause time	No effect	No effect	No effect	Off
Opening	Closes both leaves	Closes leaf	Stops	Stops; gate closes when reversing device no longer triggered	No effect	On
Opened	Closes both leaves	Closes leaf	Stops	No effect	Gate remains open until reversing devices no longer triggered	On
Closing	Opens both leave	Opens leaf	Stops	No effect	Depends on DIP switch 4	Flashes
Stopped	Closes the leaves	Closes the leaf	No effect (opening is inhibited)	No effect	No effect (opening is inhibited)	On

B (Manned, Pulsed) Logic (455 D)

Gate Status	Open A	Open B	Stop	Opening Reversing Device(s)	Closing Reversing Device(s)	Warning Light
Closed	Opens 1 or both leaves	No effect	No effect	No effect	No effect	Off
Opening	No effect	No effect	Stops	No effect	Stops	On
Opened	No effect	Closes 1 or both leaves	No effect	No effect	No effect	On
Closing	No effect	No effect	Stops	Stops	No effect	Flashes
Stopped	Opens 1 or both leaves	Closes 1 or both leaves	No effect	No effect	No effect	On

E (Semi-automatic) Logic (455 D)

Gate Status	Open A	Open B	Stop	Opening Reversing Device(s)	Closing Reversing Device(s)	Warning Light
Closed	Opens both leaves	Opens single leaf connected to Motor 1	No effect	No effect	No effect	Off
Opening	Stops	Stops	Stops	Stops; gate closes when reversing device no longer triggered	No effect	On
Opened	Closes both leaves	Closes leaf	Stops	No effect	No effect (opening is inhibited)	On
Closing	Closes both leaves	Closes leaf	Stops	No effect (opening is inhibited)	Depends on DIP switch 4	Flashes
Stopped	Closes the leaves	Closes the leaf	No effect (opening is inhibited)	No effect	No effect (opening is inhibited)	On

EP (Semi-automatic, Step by Step) Logic (455 D)

Gate Status	Open A	Open B	Stop	Opening Reversing Device(s)	Closing Reversing Device(s)	Warning Light
Closed	Opens both leaves	Opens single leaf connected to Motor 1	No effect (opening is inhibited)	No effect (opening is inhibited)	No effect (opening is inhibited)	Off
Opening	Stops	Stops	Stops	Stops; gate closes when reversing device no longer triggered	No effect	On
Opened	Closes both leaves	Closes leaf	Stops	No effect	No effect (opening is inhibited)	On
Closing	Stops	Stops	Stops	No effect (opening is inhibited)	Depends on DIP switch 4	Flashes
Stopped	Gate leaves reverse direction	Gate leaf reverses direction	No effect (opening is inhibited)	No effect (opening is inhibited)	No effect (opening is inhibited)	On

C (Manned and Constant) Logic (455 D)

Gate Status	Open A	Open B	Stop	Opening Reversing Device(s)	Closing Reversing Devices(s)	Warning Light
Closed	Opens 1 or both leaves	No effect	No effect	No effect	No effect	Off
Opening	No effect	No effect	Stops	No effect	Stops	On
Opened	No effect	Closes 1 or both leaves	No effect	No effect	No effect	On
Closing	No effect	No effect	Stops	Stops	No effect	Flashes
Stopped	Opens 1 or both leaves	Closes 1 or both leaves	No effect	No effect	No effect	On

MAINTENANCE

THE 422 COMPACT OPERATOR

The FAAC recommended maintenance schedule varies according to the frequency of use of the operators, whether lightly used operators (once or twice an hour) or heavily used operators (many cycles per hour). Operators used in a humid/ salt air climate should follow the heavy duty use schedule.

Check the oil.

To check the oil level correctly, remove the locking cap from the operator. The operator should be at least half full.

Note: You will not be able to see the oil level. Use something flexible (i.e. A piece of stranded wire) to act as a dipstick.

If the operator is too full, it will bleed oil out the vent hole.

Light duty use: check once per year
Heavy duty use: check every 6 mo

Change the oil.

Changing the oil requires removing the operator from its installed position. Remove the locking cap and drain the oil out of the hole under the cap. Refill the operator with the proper new oil (see page 4).

Light duty use: change every 4 yr
Heavy duty use: change every 2 yr

Check the pressure settings.

Light duty use: check once per year
Heavy duty use: check every 6 mo

THE 455 D CONTROL PANEL

Keep the Control Panel free from spider webs, insects, etc. Otherwise the Control Panel requires no maintenance.

SAFETY IN GATE DESIGN

- A gate is a potential traffic hazard, so it is important that you locate the gate far enough away from the road to eliminate the potential of traffic getting backed up. This distance is affected by the size of the gate, how often it is used, and how fast the gate operates.
- The operator you choose to install on your gate must be designed for the type and size of your gate and for the frequency with which you use the operator.
- Your gate must be properly installed and must work freely in both directions *before* the automatic operator is installed.
- An automatic operator should be installed on the inside of the property/fence line. Do not install the operator on the public side of the property/fence line.
- Outward swinging gates with automatic operators should not open into a public area.
- Pedestrians should not use a vehicular gate system. Prevent such inappropriate use by installing separate gates for pedestrians.
- The operating controls for an automatic gate must be secured to prevent the unauthorized use of those controls.
- The controls for an automatic gate should be located far enough from the gate so that a user cannot accidentally touch the gate when operating the controls.
- Exposed, reachable pinch points on a gate are potentially hazardous and must be eliminated or guarded.
- It is extremely unsafe to compensate for a damaged gate by over tightening a clutch or increasing hydraulic pressure.
- An automatic gate operator should not be installed on a gate if people can reach or extend their arms or legs through the gate. Such gates should be guarded or screened to

TROUBLESHOOTING

WARNING! Before you do any work on the control panel, be sure to turn off the main power.

NOTE: Any control panel specific information in the following applies to the 455 D control panel only.

PROBLEM: THE GATE DOES NOT RESPOND TO AN ACTIVATING SIGNAL.

SOLUTION:

You should have at least one operator wired to terminals 3, 4, and 5.

Be sure that you have the motor start capacitors wired in with the directional leads. See Figure 11.

Be sure that the torque potentiometer is turned all the way clockwise.

Verify that the LEDs DL3, DL4, and DL5 are illuminated. If they are not illuminated, be sure that you have closed circuits in the stop and reversing input terminals as shown in Figure 9.

Verify that your activating device works properly. DL1 should illuminate when you signal the gate to open. If DL1 does not illuminate when you signal the gate, then the problem may be in your activating device. Short across terminals 18 and 19. If the short causes the gate to open, then the problem is in the activating device. Repair or replace the device.

PROBLEM: THE GATE DOESN'T OPEN (OR CLOSE) THOUGH THE MOTORS ARE RUNNING.

SOLUTION:

Make sure that the motor is running in the right direction, and make sure the Manual Release mechanism has fully engaged the hydraulic system.

PROBLEM: THE GATE OPENS BUT DOES NOT CLOSE.

SOLUTION:

Make sure you have selected the desired operating mode.

Verify that the reversing devices are working properly. DL4 and DL5 should be illuminated except when a reversing device is triggered. If either does not illuminate, then one of your reversing devices is

preventing the gate from responding to your signal. Check your reversing devices.

If no reversing devices are installed, make sure a circuit is installed between appropriate terminals.

PROBLEM: THE GATE DOES NOT FULLY OPEN (OR CLOSE).

SOLUTION:

Check the operator's open/ close time selection. You should set a time that is just longer than the rated speed of your model of operator. For example, because the 422 CBAC has a rated opening time of 12 sec, you should set the time at 19 or 20 seconds.

Check to see that there are no obstructions in the path of the gate or that the hinges are not binding.

PROBLEM: THE OPERATOR DOESN'T WORK SMOOTHLY AND THE GATE JERKS AS IT OPENS AND CLOSES.

SOLUTION:

Check the oil level in the operator.

Make sure the Manual Release mechanism has fully engaged the hydraulic operation of the operator.

Bleed the air from the hydraulic system. (See page 10)

Make sure that a flexible gate leaf is not the problem. If the gate leaf flexes, then stiffen the gate or use a slower operator.

PROBLEM: THE GATE DRIFTS OPEN OR CLOSE WHEN THE MOTOR IS NOT RUNNING.

SOLUTION:

Remove the manual release valve, located next to the pressure adjustment screws, with a 6mm hex key. Be sure that the white ring and the o'ring are not damaged. If not damaged, there may be internal damage and a seal kit will be needed to rebuild the unit.

LIMITED WARRANTY

To the original purchaser only: FAAC International, Inc., warrants, for twenty-four (24) months from the date of invoice, the gate operator systems and other related systems and equipment manufactured by FAAC S.p.A. and distributed by FAAC International, Inc., to be free from defects in material and workmanship under normal use and service for which it was intended *provided* it has been properly installed and operated. FAAC International, Inc.'s obligations under this warranty shall be limited to the repair or exchange of any part of parts manufactured by FAAC S.p.A. and distributed by FAAC International, Inc. Defective products must be returned to FAAC International, Inc., freight prepaid by purchaser, within the warranty period. Items returned will be repaired or replaced, at FAAC International, Inc.'s option, upon an examination of the product by FAAC International, Inc., which discloses, to the satisfaction of FAAC International, Inc., that the item is defective. FAAC International, Inc. will return the warranted item freight prepaid. The products manufactured by FAAC S.p.A. and distributed by FAAC International, Inc., are not warranted to meet the specific requirements, if any, of safety codes of any particular state, municipality, or other jurisdiction, and neither FAAC S.p.A. or FAAC International, Inc., assume any risk or liability whatsoever resulting from the use thereof, whether used singly or in combination with other machines or apparatus.

Any products and parts not manufactured by FAAC S.p.A. and distributed by FAAC International, Inc., will carry only the warranty, if any, of the manufacturer. This warranty shall not apply to any products or parts thereof which have been repaired or altered, without FAAC International, Inc.'s written consent, outside of FAAC International, Inc.'s workshop, or altered in any way so as, in the judgment of FAAC International, Inc., to affect adversely the stability or reliability of the product(s) or has been subject to misuse, negligence, or accident, or has not been operated in accordance with FAAC

International, Inc.'s or FAAC S.p.A.'s instructions or has been operated under conditions more severe than, or otherwise exceeding, those set forth in the specifications for such product(s). Neither FAAC S.p.A. or FAAC International, Inc., shall be liable for any loss or damage whatsoever resulting, directly or indirectly, from the use or loss of use of the product(s). Without limiting the foregoing, this exclusion from liability embraces a purchaser's expenses for downtime or for making up downtime, damages for which the purchaser may be liable to other persons, damages to property, and injury to or death of any persons. Neither FAAC S.p.A. or FAAC International, Inc., assumes nor authorizes any person to assume for them any other liability in connection with the sale or use of the products of FAAC S.p.A. or FAAC International, Inc. The warranty hereinabove set forth shall not be deemed to cover maintenance parts, including, but not limited to, hydraulic oil, filters, or the like. No agreement to replace or repair shall constitute an admission by FAAC S.p.A. or FAAC International, Inc., of any legal responsibility to effect such replacement, to make such repair, or otherwise. This limited warranty extends only to wholesale customers who buy directly through FAAC International, Inc.'s normal distribution channels. FAAC International, Inc., does not warrant its products to end consumers. Consumers must inquire from their selling dealer as to the nature and extent of that dealer's warranty, if any.

This warranty is expressly in lieu of all other warranties expressed or implied including the warranties of merchantability and fitness for use. This warranty shall not apply to products or any part thereof which have been subject to accident, negligence, alteration, abuse, or misuse or if damage was due to improper installation or use of improper power source, or if damage was caused by fire, flood, lightning, electrical power surge, explosion, wind storm, hail, aircraft or vehicles, vandalism, riot or

FAAC International, Inc.
303 Lexington Avenue
Cheyenne, WY 82007
www.faacusa.com